

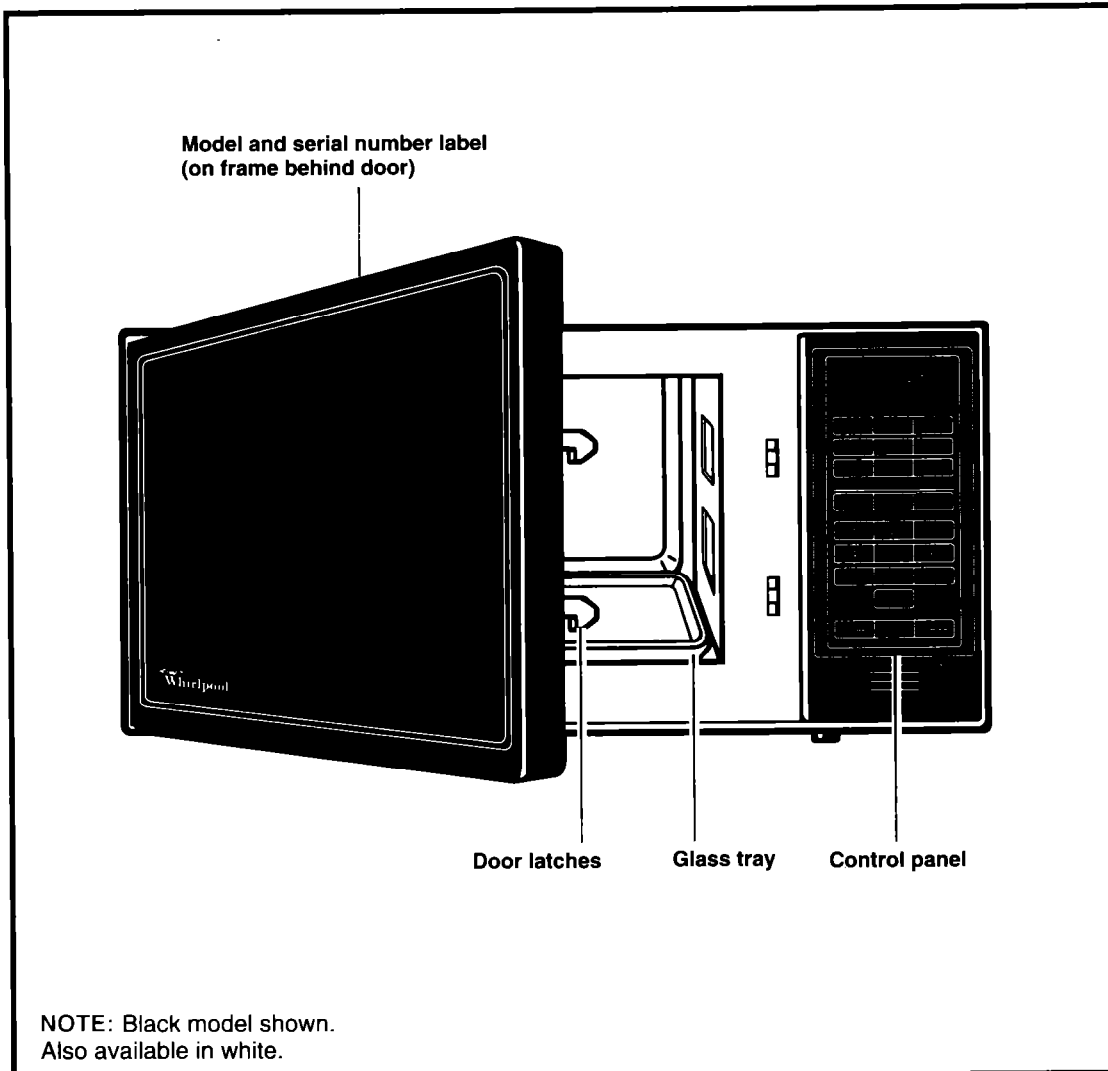

User's Manual



NOTE: Black model shown.
Also available in white.

**MICROWAVE OVEN
MS3080XB**

5/95

Contents

	Page
Important Safety Instructions	3
Precautions To Avoid Possible Exposure To Excessive Microwave Energy	4
Getting Acquainted	5
Microwave oven features	5
Control panel features	6
Quick reference cooking guide	7
Using Your Microwave Oven	10
Microwave oven controls	10
Audible signals	11
Setting the clock	11
Using OFF/CANCEL	11
Cooking in your microwave oven	12
Cooking at high cook power	12
Cooking at lower cook powers	13
Auto cooking	14
Auto weight defrosting	15
Cooking automatically after defrosting	17
Cooking with more than one cook cycle	18
Using child lock	20
Using WARM HOLD	21
Using the Minute Timer	22
Using delayed start	23
Installation Instructions	25
Grounding instructions	26
Caring For Your Microwave Oven	27
How Your Microwave Oven Works	28
Operating Safety Precautions	29
Glass tray	31
General information	32
If You Need Service Or Assistance	33
Cooking Guide	35
Whirlpool Microwave Oven Warranty	64

© 1994 Whirlpool Corporation

Thank you for buying a Whirlpool® appliance. Please complete and mail the Owner Registration Card provided with this product. Then complete the form below. Have this information ready if you need service or call with a question.

- Copy model and serial numbers from label (behind the microwave oven door on the frame) and purchase date from sales slip.
- Keep this book and the sales slip together in a handy place.

Model Number

Serial Number

Purchase Date

Service Company Phone Number

Fill out and return the Microwave Registration Card included with your microwave oven. If the card is missing, please send the model and serial number of your microwave oven, with your name and address to ...

Whirlpool Corporation
Microwave Registration Department
Administrative Center
2000 N State Route 63
Benton Harbor, MI 49022-2692

This information will help us reach you if there is ever a need to pass along information about your microwave oven.

IMPORTANT SAFETY INSTRUCTIONS

Microwave ovens have been thoroughly tested for safe and efficient operation. However, as with any appliance, there are special installation and safety precautions which must be followed to ensure safe and satisfactory operation and prevent damage to the unit.

WARNING

To reduce the risk of burns, fire, electrical shock, injury to persons, exposure to excessive microwave energy, or damage when using the microwave oven, follow basic precautions, including the following:

- Read all instructions before using the microwave oven.
- Read and follow the specific "PRECAUTIONS TO AVOID POSSIBLE EXPOSURE TO EXCESSIVE MICROWAVE ENERGY" found on page 4.
- This appliance must be grounded. Connect only to properly grounded outlet. See "GROUNDING INSTRUCTIONS" found on page 26.
- Install or locate this appliance only in accordance with the provided Installation Instructions found on page 25.
- Some products such as whole eggs and sealed containers—for example, closed glass jars—could explode and should not be heated in this oven.
- Use this appliance only for its intended use as described in this manual. Do not use corrosive chemicals or vapors in this appliance. This type of oven is specifically designed to heat, cook, or dry food. It is not designed for industrial or laboratory use.
- As with any appliance, close supervision is necessary when used by children.
- Do not operate this appliance if it has a damaged cord or plug, if it is not working properly, or if it has been damaged or dropped. Electrical shock, fire or other hazards could result.
- This appliance should be serviced only by qualified service personnel. Call an authorized Whirlpool® service company for examination, repair or adjustment.
- Do not cover or block any opening on the appliance. Fire could result.
- Do not store or use this appliance outdoors. Do not use this product near water—for example, near a kitchen sink, in a wet basement, or near a swimming pool, and the like.
- Do not immerse cord or plug in water.
- Keep cord away from heated surfaces.
- Do not let cord hang over edge of table or counter.
- See door surface and interior cleaning instructions on page 27.
- To reduce the risk of fire in the oven cavity:
 - Do not overcook food. Carefully attend appliance if paper, plastic, or other combustible materials are placed inside the oven to facilitate cooking. Paper could char or burn, and some plastics could melt if used when heating foods.
 - Do not deep fry in oven.
 - **Test dinnerware or cookware before using.** See page 32. Some dishes (melamine, some ceramic dinnerware, etc.) absorb microwave energy, becoming too hot to handle and slowing cooking times. Cooking in metal containers not designed for microwave use could damage the oven, as can containers with hidden metal (twist-ties, foil lining, staples, metallic glaze or trim).
 - Remove wire twist-ties from paper or plastic bags before placing bag in oven.
 - If materials inside the oven should ignite, keep oven door closed, turn oven off, and disconnect the power cord, or shut off power at the fuse or circuit breaker panel.
 - Do not use the cavity for storage purposes. Do not leave paper products, cooking utensils, or food in the cavity when not in use.
 - Do not operate any heating or cooking appliance beneath this appliance.
 - Do not mount unit over or near any portion of a heating or cooking appliance.
 - Do not mount over a sink.
 - Do not store anything directly on top of the appliance when appliance is in operation.
- Read and follow "Operating Safety Precautions" starting on page 29.
 1. A short power-supply cord is provided to reduce the risks resulting from becoming entangled in or tripping over a longer cord.
 2. Longer cord sets or extension cords are available and may be used if care is exercised in their use.

continued on next page

3. If a long cord or extension cord is used temporarily, (a) the marked electrical rating of the cord set or extension cord should be at least as great as the electrical rating of the appliance, (b) the extension cord must be a grounding-type, 3-wire cord that has a 3-blade grounding plug and a 3-slot receptacle that will accept the plug on the appliance, and (c) the longer cord should be arranged so that it will not drape over the countertop or tabletop where it can be pulled on by children or tripped over accidentally.
4. A qualified electrician must install a properly grounded and polarized 3-prong receptacle near the appliance.

You are responsible for:

- Installing and leveling the oven on a surface strong enough to support its weight, and where it is protected from the elements.* The microwave oven should be at a temperature above 50°F (10°C) for proper operation.
- Properly connecting the oven to electrical supply and grounding it.*
- Operating the oven with the glass tray in place.
- Making sure the oven is not used by anyone unable to operate it properly.
- Properly maintaining the oven.
- Using the microwave oven only as described in this manual.

*See the Installation Instructions on page 25.

– SAVE THESE INSTRUCTIONS –

PRECAUTIONS TO AVOID POSSIBLE EXPOSURE TO EXCESSIVE MICROWAVE ENERGY...

Do not attempt to operate this oven with the door open since open-door operation can result in harmful exposure to microwave energy. It is important not to defeat or tamper with the safety interlocks.

Do not place any object between the oven front face and the door or allow soil or cleaner residue to accumulate on sealing surfaces.

Do not operate the oven if it is damaged. It is particularly important that the oven door close properly and that there is no damage to the:

- (1) Door (bent),
- (2) Hinges and latches (broken or loosened),
- (3) Door seals and sealing surfaces.

Do not operate the microwave oven if the door window is broken.

The microwave oven should be checked for microwave leakage by qualified service personnel after a repair is made.

The oven should not be adjusted or repaired by anyone except properly qualified service personnel.

Do not operate the microwave oven with the outer cabinet removed.

Getting Acquainted

Microwave oven features

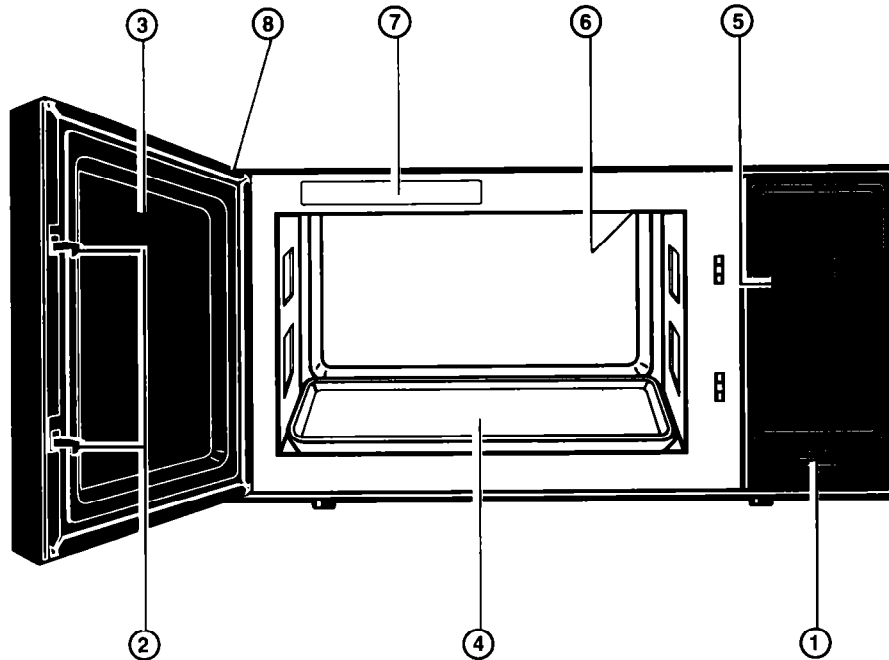

Your microwave oven is designed to make your cooking experience as enjoyable and productive as possible. To help get you up and running quickly, the following is a list of the oven's basic features:

1. **Door Open Button.** Push button to open door. Door must be pressed firmly shut for oven to operate.
2. **Door Safety Lock System.** The oven will not operate unless the door is securely closed.
3. **Window with Metal Shield.** Shield prevents microwaves from escaping. It is designed as a screen to allow you to view food as it cooks.
4. **Glass Tray.** This tray must be in oven during operation for best cooking results. See pages 27 and 31 for more details.
5. **Control Panel.** Touch pads on this panel to perform all functions. See page 6 for more details.
6. **Light.** Automatically turns on when door is opened or when oven is operating.
7. **Model and Serial Number Label.**
8. **External Oven Air Vents (on side).** See page 25 for more details.

Control panel features

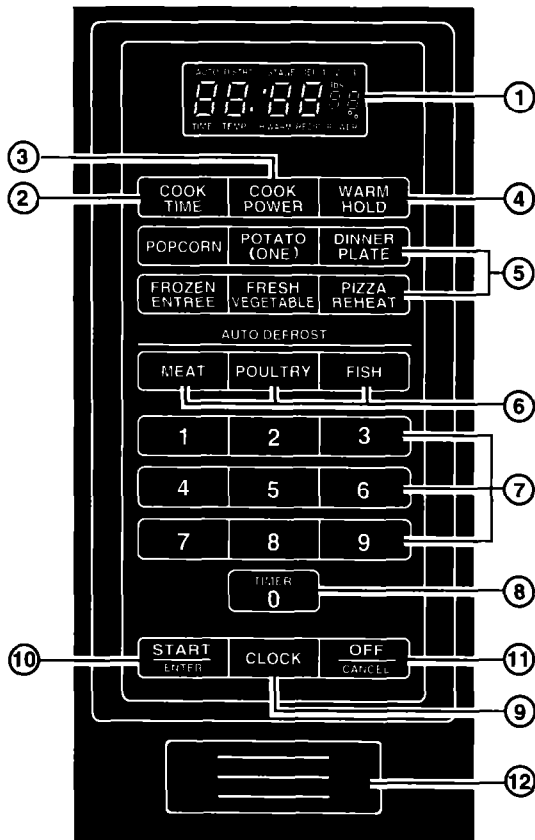





Your microwave oven control panel lets you select the desired cooking function quickly and easily. All you have to do is touch the necessary Command Pad. The following is a list of all the Command and Number Pads located on the control panel. For more information, see pages 10-24.

1. **Display.** This display includes a clock and indicators to tell you time of day, cooking time settings and cooking functions selected. See page 10 for more information.

2. **COOK TIME.** Touch this pad when cooking at Cook Power or cooking automatically after defrosting. Touch COOK TIME to set the first, second and third Cook cycles when cooking at more than one Cook Power. Touch this Command Pad when setting the Minute Timer or a delayed start time.
3. **COOK POWER.** Touch this pad followed by a Number Pad to set the amount of microwave energy released to cook the food. The higher the number, the higher the power or the faster the cooking. See page 13 for more information. See the "Cooking Guide," starting on page 35, for specific Cook Powers to use for the foods you are cooking.
4. **WARM HOLD.** Touch this pad to keep food warm for up to 60 minutes. See page 21 for more information.
5. **Auto Cooking.** Select to cook popcorn, pizza, fresh vegetables, a frozen entree, baked potato or a dinner plate. See page 14 for more information.
6. **AUTO DEFROST.** Select these pads followed by Number Pads to thaw frozen food before cooking. See pages 15-16 for more information.
7. **Number Pads.** Touch a Number Pad after touching a Command Pad to tell the oven what time, Cook Power or Defrosting Weight you wish to enter.
8. **"0" Number Pad.** Touch this Number Pad when setting the Minute Timer or Delayed Start. See pages 22-24 for more information.
9. **CLOCK.** Touch this pad followed by Number Pads to set time of day. See page 11 for more information.
10. **START/ENTER.** Touch this pad after setting a function on the microwave oven to start the function. If you open the door before the oven begins to cook, retouch START/ENTER.
11. **OFF/CANCEL.** Touch this pad to stop the oven or to cancel the program. See page 11 for more information.
12. **Door Open Button.**

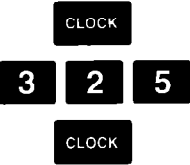
Quick reference cooking guide

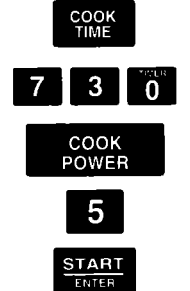
Your microwave oven gives you a wide range of cooking capabilities. The following chart can be used as a quick reference when cooking. For more in-depth information, see the corresponding sections in this Use and Care Guide.

If you want to ...	You ...	Example ...
<p>Set the clock Setting the clock to the correct time of day lets you set start times with the Delayed Start feature. The microwave clock also provides an accurate source of time for your kitchen.</p>	<ol style="list-style-type: none"> 1. Touch CLOCK. 2. Touch Number Pads for the correct time of day. 3. Touch CLOCK. 	
<p>Cook at high power High power cooking is perfect for quick cooking of small items and separate portions.</p>	<ol style="list-style-type: none"> 1. Put food in the oven and close the door. 2. Touch COOK TIME. 3. Touch Number Pads for the cooking time you want. 4. Touch START/ENTER. 	
<p>Cook at lower powers Cooking at lower powers is necessary for efficient cooking of most foods. Failure to use the correct Cook Power may result in overcooking or undercooking.</p>	<ol style="list-style-type: none"> 1. Put food in the oven and close the door. 2. Touch COOK TIME. 3. Touch Number Pads for the cooking time you want. 4. Touch COOK POWER. 5. Touch a Number Pad for the Cook Power you want. 6. Touch START/ENTER. 	
<p>Operate auto cooking Auto Cooking allows you to choose from six commonly used cooking times by touching just two pads.</p>	<ol style="list-style-type: none"> 1. Put food in the oven and close the door. 2. Select appropriate Command Pad. 	
<p>Defrost Auto Weight Defrosting decreases the amount of time needed to thaw frozen food before cooking.</p>	<ol style="list-style-type: none"> 1. Put food in the oven and close the door. 2. Touch MEAT, POULTRY or FISH. 3. Touch Number Pads for the defrosting weight you want in pounds. 4. Touch START/ENTER. 	

continued on next page

**Getting Acquainted
Continued**

If you want to ...	You ...	Example ...
<p>Cook with more than one cycle Cooking with two or three cycles lets you cook at different Cook Powers, one after another. Using this function, you are able to fine-tune your cooking for better results.</p>	<ol style="list-style-type: none"> Put food in the oven and close the door. Touch COOK TIME. Touch Number Pads for the cooking time you want in the first cycle. Touch COOK POWER. (To use HIGH power, skip to Step 6.) Touch a Number Pad for the Cook Power you want in the first cycle. Touch COOK TIME. Touch Number Pads for the cooking time you want in the second cycle. Touch COOK POWER. (To use HIGH power, skip to Step 10.) Touch a Number Pad for the Cook Power you want in the second cycle. Touch COOK TIME. Touch Number Pads for the cooking time you want in the third cycle. Touch COOK POWER. (To use HIGH power, skip to Step 14.) Touch a Number Pad for the Cook Power you want in the third cycle. Touch START/ENTER. 	
<p>Operate Child Lock The Child Lock feature lets you inactivate the microwave power.</p>	<ol style="list-style-type: none"> Touch OFF/CANCEL. Touch and hold "0" until "L" appears at the left of the Display and a single tone is heard. To cancel: Repeat the above steps. 	
<p>Keep food warm The Warm Hold feature lets you keep food warm in your microwave oven for up to 1 hour.</p>	<ol style="list-style-type: none"> Put cooked, hot food in the oven and close the door. Touch WARM HOLD. Touch START/ENTER. 	

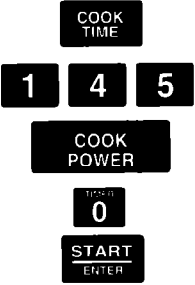
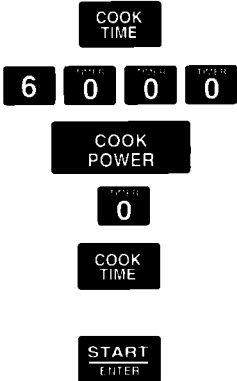
If you want to ...	You ...	Example ...
<p>Use the Minute Timer The Minute Timer lets you time any cooking activities in your kitchen.</p>	<ol style="list-style-type: none"> 1. Touch COOK TIME. 2. Touch Number Pads for the minutes and seconds you want. 3. Touch COOK POWER. 4. Touch the "0" Number Pad. 5. Touch START/ENTER. 	 <p>The diagram illustrates the sequence of button presses for the Minute Timer. It starts with the 'COOK TIME' button, followed by the number pads '1', '4', and '5'. Next is the 'COOK POWER' button, then the '0' number pad, and finally the 'START/ENTER' button.</p>
<p>Start cooking automatically at a later time The Delayed Start feature is a handy way to start cooking a meal whenever you want, even when you are not there.</p>	<ol style="list-style-type: none"> 1. Put food in the oven and close the door. 2. Touch COOK TIME. 3. Touch Number Pads for the length of delay you want in minutes and seconds. 4. Touch COOK POWER. 5. Touch the "0" Number Pad. 6. Touch COOK TIME. 7. Touch in the cooking time and Cook Power (if needed) for the Cook cycle. 8. Touch START/ENTER. 	 <p>The diagram illustrates the sequence of button presses for the Delayed Start feature. It starts with the 'COOK TIME' button, followed by the number pads '6', '0', '0', and '0'. Next is the 'COOK POWER' button, then the '0' number pad, followed by another 'COOK TIME' button, and finally the 'START/ENTER' button.</p>

Using Your Microwave Oven

Microwave oven controls

There are three parts in the control section:

- Display/Clock and Indicators
- Command Pads
- Number Pads

Instructions for each control are covered on the following pages. Read them carefully.

When you first plug in the oven, a tone will sound and the Display will show "12:00⁰⁰". The clock will begin to run. The Display shows the time in hours, minutes and seconds. Set the clock to the correct time of day (page 11). If your electricity goes off for a while and comes back on, the clock will return to "12:00⁰⁰" and begin to run. Reset the clock.

Display/clock and indicators

When you are not using the microwave oven, this is an accurate clock.

When you are using the microwave oven, it displays time settings, cook power settings, defrost weight settings and indicators.

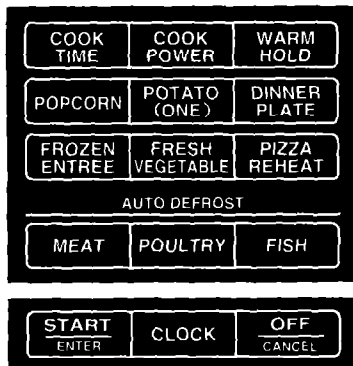
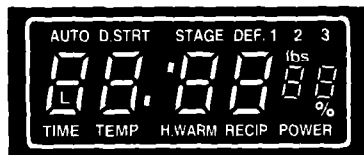

Command pads

- Touch Command Pads to tell the microwave oven what to do and in what order. A few examples:
 - CLOCK tells the oven you are going to set the clock.
 - START/ENTER tells the oven to start. (See page 11 for information on the tone you hear when touching any pad.)
- Each Command Pad (except START/ENTER, OFF/CANCEL, and CLOCK) causes an Indicator to light when you touch the Command Pad. While the oven is running, an Indicator (or Indicators) will be on to show what the oven is doing.
- If you touch two instructions into the same cycle, the second set of instructions will cancel the first.

Number pads

Once you've touched a Command Pad to tell the oven what you want it to do, you'll touch Number Pads to tell it ...

- a Time,
- a Cook Power,
- a Defrosting Weight.

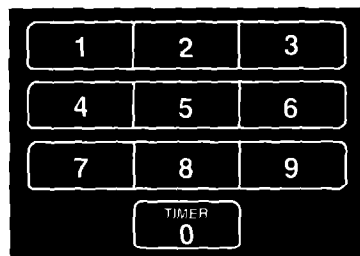



Display messages

Messages will appear on the display to guide you with your cooking. If you attempt to enter unacceptable instructions, "Err" will appear on the Display. Touch OFF/CANCEL and re-enter the instructions.

Audible signals

Audible signals are available to guide you when setting and using your oven. A programming tone will sound each time you touch a pad. Two tones will sound between cycles. Three tones signal the end of a Cook or Defrost cycle. If you do not hear a tone, it is because of incorrectly entered instructions.

Setting the clock

When the oven is first plugged in, a tone sounds and the Display shows "12:00⁰⁰". If the electric power ever goes off, the Display will again show "12:00⁰⁰" when the power comes back on.

You can cook without setting the clock, but the Display will show "12:00⁰⁰" (plus the hours, minutes and seconds that have elapsed since the oven was plugged in).

1. To set the clock, touch CLOCK. The Display will show "12:00⁰⁰" (if time of day has not been set before) or the time previously set. The colon will disappear.
2. Touch Number Pads for the correct time of day. The Display will show what numbers you touched **in the order you touched them**. This example shows 3:25.
3. Touch CLOCK. The colon will appear without blinking and the seconds (in small display on the right) count up. The Clock is set.
If you have touched in an incorrect time, such as 12:65, "Err" will show on the Display. Touch CLOCK and start over.

NOTE: To reset the clock, touch CLOCK. The current time will show on the Display and the colon will disappear. Continue to set the clock as shown above.

Using OFF/CANCEL

Touch OFF/CANCEL to:

- Erase instructions if you make a mistake during programming.
- Cancel the Minute Timer.
- Stop the oven temporarily during cooking.

NOTE: The oven may also be stopped during a cycle by opening the door. Close the door and touch START/ENTER to restart.

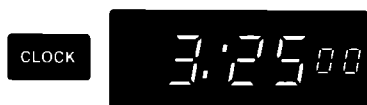
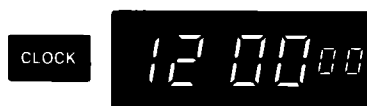

Cooking in your microwave oven

Although a new rating method* rates these ovens at 800 watts, you may use a reliable cookbook with recipes developed for microwave ovens previously rated at 750 watts.

To get the best cooking results:

- ALWAYS cook food for the minimum recommended cooking time. If necessary, add time in one or two minute periods, then check for doneness to avoid overcooking the food.
- Stir, turn over or rearrange the food being cooked about halfway through the cooking time for most even doneness with all recipes.
- If a glass cover is not available, use wax paper, paper towels or microwave-approved plastic wrap. Turn back a corner to vent steam during cooking.
- ALWAYS cook food with glass tray in place.

*The IEC-705 Test Procedure Wattage Rating. The IEC-705 Test Procedure is an internationally recognized method of rating microwave wattage output and does not represent an actual change to output power or cooking performance.

Cooking at high cook power

Follow these steps to cook at **HIGH** power:

1. Put food in the oven and close the door.
2. Touch COOK TIME. The Display will show STAGE 1, 0, HI and % POWER, and the TIME Indicator will start to flash.
3. Touch Number Pads for the cooking time you want. The Display will show the numbers you touched **in the order you touched them**. The example shows 1 minute, 30 seconds.
4. Touch START/ENTER. The oven will automatically cook at HIGH Cook Power. The STAGE 1, HI and % POWER Indicators will show and the TIME Indicator will disappear.

When the cooking time ends, "End" will show on the Display and two short and one long tone will sound. (You can stop the tones by opening the door or by touching OFF/CANCEL.) "End" will remain on the Display until the door is opened or OFF/CANCEL is touched. The Display will then show the time of day.



Cooking at lower cook powers

For best results, some recipes call for lower Cook Powers. The lower the Cook Power, the slower the cooking. Each Number Pad also stands for a different percentage of Cook Power. Many recipes in the Cooking Guide tell you, by number, which Cook Power to use. Recipes in other books and magazines may tell you by name (HI, MED, LO, etc.) or percentage (10%, 50%, 80%, etc.).

The following chart gives the percentage of Cook Power each Number Pad stands for, and Cook Power name usually used:

Automatic 100% of full power HIGH

9=90% of full power

8=80% of full power

7=70% of full power MED-HIGH

6=60% of full power

5=50% of full power MED

4=40% of full power

3=30% of full power MED-LOW

2=20% of full power

1=10% of full power LOW

0=TIMER (fan and light will be off)



1. Put food in the oven and close the door.
2. Touch COOK TIME. The Display will show the STAGE 1, 0, HI and % POWER Indicators, and the TIME Indicator will start to flash.
3. Touch Number Pads for the cooking time you want. The Display will show the numbers you touched **in the order you touched them**. This example shows 7 minutes, 30 seconds.
4. Touch COOK POWER. The Display will show the STAGE 1 and HI Indicators and the % POWER Indicator will start to flash. This shows the oven is preprogrammed to cook at full (HIGH) power.
5. Touch a Number Pad for the Cook Power you want. The Display will show what you touched. This example shows you touched Number Pad 5 for 50% of full power.
6. Touch START/ENTER. The STAGE 1 and % POWER Indicators will stay on to show that the oven is cooking in the first cycle at a Cook Power other than HIGH.

The Display counts down the time to show how much cooking time is left in the cycle.

When the cooking time ends, "End" will show on the Display and two short and one long tone will sound. (You can stop the tones by opening the door or by touching OFF/CANCEL.) "End" will remain on the Display until the door is opened or OFF/CANCEL is touched. The Display will then show the time of day.

Auto cooking

Auto cooking provides six preset times. This provides a short-cut method for setting commonly used cooking times. This function allows you to cook popcorn, a baked potato, a dinner plate, a frozen entree, fresh vegetables, or reheat pizza by selecting the proper key. This example shows the Pizza Reheat cycle.

1. Put food in the oven and close the door.
2. Touch PIZZA REHEAT. "Auto" appears on the Display.
3. The oven will begin the Auto Cooking cycle you selected and the Display will show the total cooking time.



**BEEP
BEEP
BEEP**

When the Pizza Reheat cycle ends, "End" will show on the Display and two short and one long tone will sound. (You can stop the tones by opening the door or by touching OFF/CANCEL.) "End" will remain on the Display until the door is opened or OFF/CANCEL is touched. The Display will then show the time of day.

Auto weight defrosting

Use Auto Weight Defrost to thaw frozen food before cooking. This example shows the use of the MEAT Command Pad. For suggested defrost weight, see the "Auto weight defrost sequence list" on the next page.

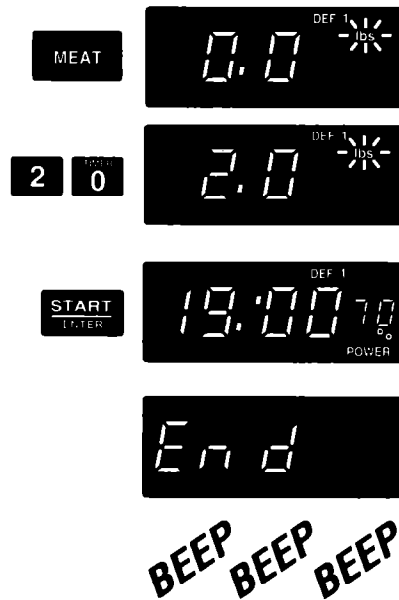

1. Put frozen food in the oven and close the door.
2. Touch MEAT. The DEF 1 and 0.0 Indicators will come on and the lbs Indicator will start to flash.
3. Touch Number Pads to enter the weight of the food you want to defrost. The Display will show the numbers you touched **in the order you touched them**. This example shows 2 lbs.
4. Touch START/ENTER. The DEF 1 and % POWER Indicators will stay on to show that the oven is in the Auto Weight Defrost cycle. This Display counts down the time to show how much defrosting time is left. When the defrost time ends, "End" will show on the Display and two short tones and one long tone will sound. (You can stop the tones by opening the door or by touching OFF/CANCEL.) "End" will remain on the Display until the door is opened or OFF/CANCEL is touched. The Display will then show the time of day.

NOTES:

- The Auto Weight Defrost feature gives you automatic setting and control of defrosting, but just like conventional defrosting you must check the foods during the defrosting time.
- For best results, remove fish, shellfish, meat and poultry from its original paper or plastic closed package (wrapper). Otherwise, the wrap will hold steam and juice close to the foods which can cause the outer surface of the foods to cook.
- When it is difficult to remove the wrap from the foods, defrost the wrapped food for stage 1 of the defrost time. At the tone, remove the wrap.
- Place foods in a shallow glass baking dish or microwave roasting rack to catch drippings.
- Food should still be somewhat icy in the center when removed from the oven.

**Using Your Microwave Oven
Continued**

Hints for better defrosting

Your microwave oven controls four different output powers automatically during the defrost cycle. After the second segment is completed, five tones will sound but the oven will continue to defrost. At the sound of the tones, open the oven door and turn the food over, close the oven door and touch START/ENTER. The oven will automatically continue to count down the amount of time left on the timer.

Auto weight defrost sequence list

SEQUENCE	FOOD	MIN/MAX FOOD WEIGHT
Meat	<ul style="list-style-type: none"> • BEEF Ground beef, Round steak, Cubes for stew, Tenderloin steak, Pot roast, Rib roast, Rump roast, Chuck roast, Hamburger patty • LAMB Chops (1-inch thick), Rolled roast • PORK Chops (½-inch thick), Hot dogs, Spareribs, Country-style ribs, Rolled roast, Sausage • VEAL Cutlets (1 lb, ½-inch thick) 	0.1/4.5 lbs
Poultry	<ul style="list-style-type: none"> • CHICKEN Whole (under 4 lbs), Cut-up Breasts (boneless) • CORNISH HENS ... Whole • TURKEY Breast (under 6 lbs) 	0.1/4.5 lbs
Fish	<ul style="list-style-type: none"> • FISH Fillets, Steaks, Whole • SHELLFISH Crabmeat, Lobster tails, Shrimp, Scallops 	0.1/4.5 lbs

NOTE: To defrost items not listed in Auto Weight Defrosting, use 30% Cook Power. See a reliable cookbook for defrosting information.

Cooking automatically after defrosting

The controls can be set so the microwave oven goes automatically from defrosting to the Cook cycle you have touched in. This example shows the use of the Meat Defrost cycle.

1. Put food in the oven and close the door.
2. Touch MEAT. The DEF 1 and 0.0 Indicators will come on and the lbs Indicator will start to flash.
3. Touch Number Pads for the defrosting weight you want. The Display will show the numbers you touched **in the order you touched them**. This example shows 2 lbs.
4. Touch COOK TIME. The Display will show the STAGE 1, 0, HI and % POWER Indicators, and the TIME Indicator will start to flash.
5. Touch Number Pads for the cooking time you want. The Display will show the numbers you touched **in the order you touched them**. This example shows 4 minutes, 30 seconds.
6. Select a Cook Power. To cook at HIGH power, skip to Step 8. To select another Cook Power, touch COOK POWER. The Display will show the STAGE 1 Indicator, and the % POWER Indicator will start to flash. This shows the oven is preprogrammed to cook at full (HIGH) power.
7. Touch a Number Pad for the Cook Power you want. The Display will show what you touched. This example shows you touched Number Pad 6 for 60% of full power.
8. Touch START/ENTER. The DEF 1, % POWER and "19:00"⁰⁰ Indicators will stay on. All other Indicators will go off. The Display counts down the time to show how much time is left in the Auto Weight Defrost cycle.

When the defrost time ends, you will hear 2 tones and the Cook cycle will start.

The STAGE 1 Indicator will be on during the Cook cycle. The desired POWER Indicator will also be on **if you are using a Cook Power other than HIGH**.

The Display counts down the time to show how much time is left in the second cycle.

When the Cook cycle ends, "End" will show on the Display and two short and one long tone will sound. (You can stop the tones by opening the door or by touching OFF/CANCEL.) "End" will remain on the Display until the door is opened or OFF/CANCEL is touched. The Display will then show the time of day.



Cooking with more than one cook cycle

For best results, some recipes call for one Cook Power for a certain length of time, and another Cook Power for another length of time. Your oven can be set to change from one to another automatically.

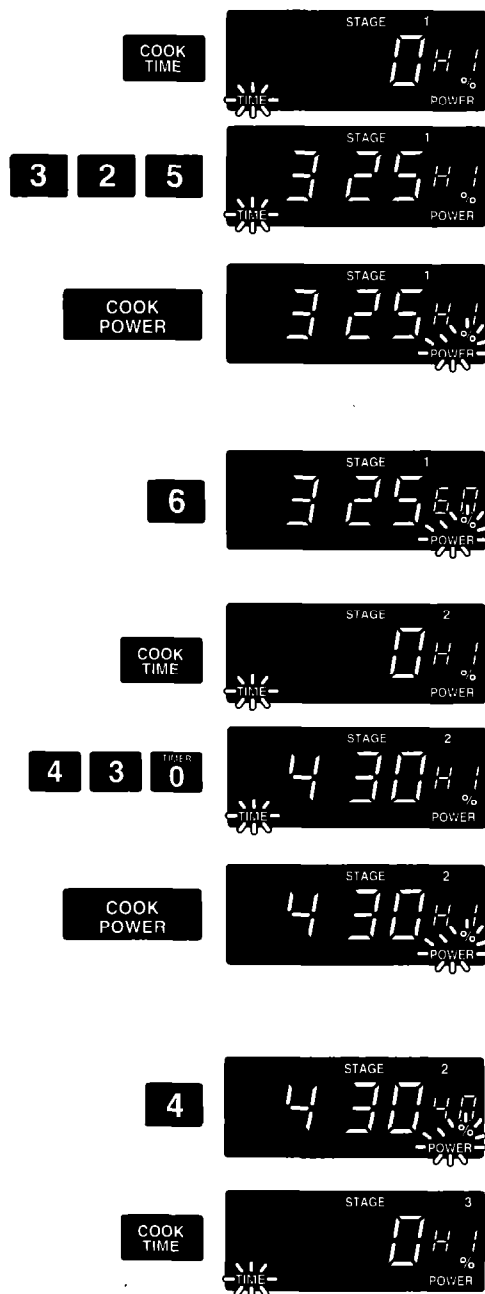

1. Put food in the oven and close the door.
2. Touch **COOK TIME**. The **STAGE 1** Indicator will come on and the Display will show "0^{HI}" and "% POWER". The **TIME** Indicator will start to flash.
3. Touch Number Pads for the cooking time you want in the first cycle. The Display will show the numbers you touched **in the order you touched them**. This example shows 3 minutes, 25 seconds.
4. Select a Cook Power. To cook at **HIGH** power, skip to Step 6. To select another Cook Power, touch **COOK POWER**. The Display will show the **STAGE 1** and **HI** Indicators and the **% POWER** Indicator will start to flash. This shows the oven is preprogrammed to cook at full (**HIGH**) power.
5. Touch a Number Pad for the Cook Power you want in the first cycle. The Display will show what you touched. This example shows you touched Number Pad 6 for 60% of full power.
6. Touch **COOK TIME**. The **STAGE 2** Indicator will come on and the Display will show "0^{HI}" and "% POWER". The **TIME** Indicator will start to flash.
7. Touch Number Pads for the cooking time you want in the second cycle. The Display will show the numbers you touched **in the order you touched them**. This example shows 4 minutes, 30 seconds.
8. Select a Cook Power. To cook at **HIGH** power, skip to Step 10. To select another Cook Power, touch **COOK POWER**. The Display will show the **STAGE 2** and **HI** Indicators and the **% POWER** Indicator will start to flash. This shows the oven is preprogrammed to cook at full (**HIGH**) power.
9. Touch a Number Pad for the Cook Power you want in the second cycle. The Display will show what you touched. This example shows you touched Number Pad 4 for 40% of full power.
10. Touch **COOK TIME**. The **STAGE 3** Indicator will come on and the Display will show "0^{HI}" and "% POWER". The **TIME** Indicator will start to flash.



BEEP BEEP



BEEP BEEP



BEEP BEEP BEEP

11. Touch Number Pads for the cooking time you want in the third cycle. The Display will show the numbers you touched **in the order you touched them**. This example shows 5 minutes.

12. Select a Cook Power. To cook at HIGH power, skip to Step 14. To select another Cook Power, touch COOK POWER. The Display will show the STAGE 3 and HI Indicators and the % POWER Indicator will start to flash. This shows the oven is preprogrammed to cook at full (HIGH) power.

13. Touch a Number Pad for the Cook Power you want in the third cycle. The Display will show what you touched. This example shows you touched Number Pad 5 for 50% of full power.

14. Touch START/ENTER. The STAGE 1 and % POWER Indicators will stay on to show that the oven is cooking in the first cycle.

The Display counts down the time to show how much cooking time is left in the first cycle.

You will hear 2 tones at the end of the first cycle. You can either open the door to check, stir or turn over the food, etc., or you can let the oven start the next cycle. If you do open the door, touch START/ENTER after closing the door to restart the oven.

The STAGE 2 Indicator will be on during the second cycle. The Display counts down the time to show how much cooking time is left in the second cycle. You will hear 2 tones at the end of the second cycle.

The STAGE 3 Indicator will be on during the third cycle. The Display counts down the time to show how much cooking time is left in the third cycle.

When the third Cook cycle ends, "End" will show on the Display and two short tones and one long tone will sound. (You can stop the tones by opening the door or by touching OFF/CANCEL.) "End" will remain on the Display until the door is opened or OFF/CANCEL is touched. The Display will then show the time of day.

Hints for cooking with more than one cycle

You can program the cooking cycles in any order. However, when the microwave oven is started, it will automatically go through the cycles in the order of the examples described in this book. For example, if you program COOK, WARM HOLD and AUTO WEIGHT DEFROST, the microwave oven will automatically follow this sequence: AUTO WEIGHT DEFROST → (STANDING TIME) → COOK → WARM HOLD.

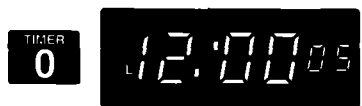

(press about 2 seconds)



(press about 2 seconds)

Using child lock

Your oven has a lockout feature that inactivates the microwave power.

To set child lock:

1. Touch OFF/CANCEL.
2. Touch and hold "0" until "L" appears at the left of the Display and a single tone is heard. In this condition, the oven will not operate. If a cooking program is set and START/ENTER is touched during the lockout phase, "Err" will appear on the Display and a long tone will be heard.

To cancel child lock:

1. Touch OFF/CANCEL.
2. Touch and hold "0" until "L" disappears from the Display and you hear a single tone. The oven is now ready to use.

Using WARM HOLD

Hot, cooked foods can be safely kept warm in your microwave oven for up to 60 minutes. WARM HOLD can be used by itself, or it can automatically follow a Cook cycle.

1. Put cooked, hot food in oven and close door.
2. Touch WARM HOLD. "Hold" will appear on the Display.



3. Touch START/ENTER. "Hold" will stay on. The oven light and the fan will come on.

NOTES:

- WARM HOLD operates for up to 60 minutes.
- Opening the oven door cancels WARM HOLD. Close the door and touch WARM HOLD, then START/ENTER if additional WARM HOLD time is desired.
- Foods cooked covered should be covered during WARM HOLD.
- Pastry items (pies, turnovers, etc.) should be uncovered during WARM HOLD.
- Complete meals kept warm on a dinner plate should be covered during WARM HOLD.
- The use of more than one complete WARM HOLD (60 minutes) is not recommended. The quality of some foods will suffer with extended time.

To automatically follow another cycle:

1. While you are touching in cooking instructions, touch WARM HOLD before touching START/ENTER. If you wish to set WARM HOLD after the oven starts operating, open the door, touch WARM HOLD and then touch START/ENTER.
2. When the last cooking cycle is over, you will hear two short tones. "Hold" will appear on the Display while the oven continues to run.
3. You can set WARM HOLD to follow both AUTO WEIGHT DEFROST and COOK.

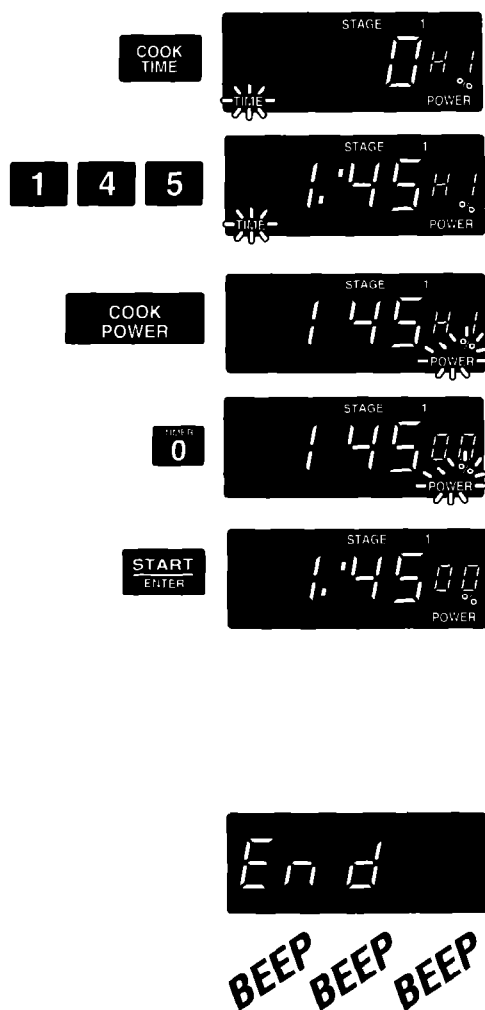

Using the Minute Timer

The microwave oven controls can be used as a minute timer. Use COOK TIME at "0" Cook Power for timing up to 99 minutes, 99 seconds.

NOTE: The oven will not operate while the Minute Timer is in use.

1. Touch COOK TIME. The STAGE 1 Indicator will come on and the Display will show "0H" and "% POWER". The TIME Indicator will start to flash.
2. Touch Number Pads for the minutes and seconds you want. The Display will show the numbers you touched **in the order you touched them**. This example shows 1 minute, 45 seconds.
3. Touch COOK POWER. The % POWER Indicator will start to flash.
4. Touch the "0" Number Pad. The small Display will show "00". This tells you the oven will be operating at 0% power.
5. Touch START/ENTER.

NOTE: If you hear the fan start when you touch START/ENTER, you have not set the Cook Power properly. Touch OFF/CANCEL and start over.

The STAGE 1 and % POWER Indicators will stay on to show you that the timer is running.

The Display counts down to show you how much time is left. During the countdown the oven will be dark and the fan will be off.

When the set time ends, "End" will show on the Display and two short tones and one long tone will sound. (You can stop the tones by opening the door or by touching OFF/CANCEL.) "End" will remain on the Display until the door is opened or OFF/CANCEL is touched. The Display will then show the time of day.

NOTE: Opening the oven door stops the countdown. Close the door and touch START/ENTER to continue the timing countdown.

Using delayed start

The microwave oven can be set to start automatically at a later time. Use the Cook cycle at "0" Cook Power to delay the start of the second Cook cycle for up to 99 minutes, 99 seconds.

1. Put food in the oven and close the door.
(See WARNING on page 24.)
2. Touch COOK TIME. The STAGE 1 Indicator will come on and the Display will show "0H" and "% POWER". The TIME Indicator will start to flash.
3. Touch Number Pads for the length of delay you want. The Display will show the numbers you touched **in the order you touched them**. This example shows 60 minutes (1 hour).
4. Touch COOK POWER. The % POWER Indicator will start to flash and the Display will show "6000H".
5. Touch the "0" Number Pad. The Display will show "6000⁰⁰". This tells you the oven will be operating at 0% power.
6. Touch COOK TIME. The STAGE 2 Indicator will come on and the Display will show "0H" and "% POWER". The TIME Indicator will start to flash.
7. Touch in the cooking time and Cook Power.
8. Touch COOK TIME. The STAGE 3 Indicator will come on and the Display will show "0H" and "% POWER". The TIME Indicator will start to flash.
9. Touch in the cooking time and Cook Power.

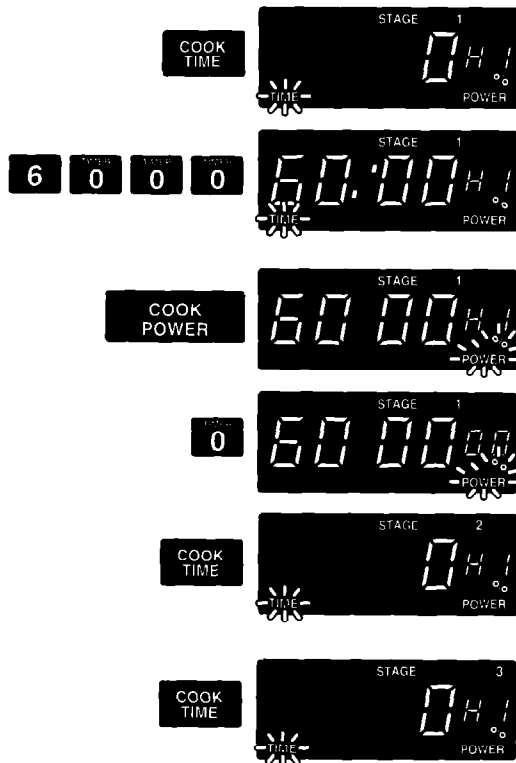

continued on next page

Using Your Microwave Oven Continued



10. Touch START/ENTER. The STAGE 1 and % POWER Indicators will stay on. During the STAGE 1 cycle the oven will be off, but the Display will count down the set time. After this time is up, the STAGE 2 and 3 cycles will begin.

NOTES:

- If you hear the fan start when you touch START/ENTER, you have not set the oven properly. Touch the OFF/CANCEL Pad and start over. When using Delayed Start, the oven cooks only during the STAGE 2 and 3 cycles.
- Do not use foods containing baking powder or yeast when using delay start. They will not rise properly.

⚠ WARNING

To avoid sickness and food waste when using delay start:

- **Do not use foods that will spoil while waiting for cooking to start, such as dishes with milk or eggs, cream soups, and cooked meats or fish. Any food that has to wait for cooking to start should be very cold or frozen before it is put in the oven. MOST UNFROZEN FOODS SHOULD NEVER STAND MORE THAN TWO HOURS BEFORE COOKING STARTS.**
- **Do not allow food to remain in oven for more than two hours after end of cooking cycle.**

Installation Instructions

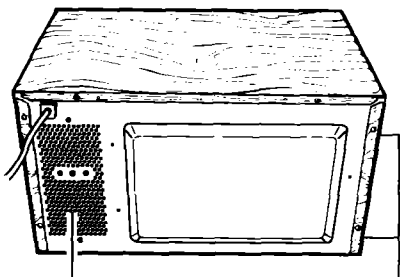
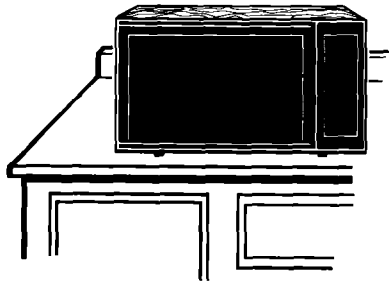
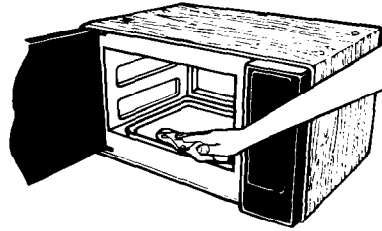

Rear air intake openings

Air vents

Before you begin, carefully read the following instructions.

1. Empty the microwave oven and clean inside it with a soft, damp cloth. Check for damage such as misaligned door, damage around the door or dents inside the oven or on the exterior. If there is any damage, please do not operate the unit until it has been checked by an authorized Whirlpool® service technician and any repairs have been made.
2. Put the oven on a cart, counter, table or shelf that is strong enough to hold the oven and the food and utensils you put in it. **(The control side of the unit is the heavy side. Use care when handling.)** The weight of the oven is approximately 31 lbs (14 kg).

⚠ WARNING

Fire, Electrical Shock, Excessive Exposure To Microwave Energy, Personal Injury and Product Damage Hazard

- Do not block the rear air intake openings and air vents on side of microwave oven. Allow a few inches of space on side and back of oven where vents and intake openings are located. Blocking the air intake openings and air vents could cause damage to the oven and poor cooking results. Make sure the microwave oven legs are in place to ensure proper airflow.
- Do not install the oven next to or over a heat source (for example a cooktop or range) or in any area where excessive heat and steam are generated. This could cause a fire, electrical shock, excessive exposure to microwave energy, other personal injury or damage to the outside of the cabinet.

Built-in kits

You can build in your microwave oven in a cabinet by using one of the following trim kits:

22½" Black – MK3082XAB (Kit No. 4319223)

22½" White – MK3082XAQ (Kit No. 4319222)

NOTE: These kits are not for use over a heat source.

You can hang your microwave oven under an upper cabinet by using one of the following kits:

Black – Kit No. 4319128

White – Kit No. 4319108

Cabinet trim kits are usually available from your Whirlpool Dealer. All kits can be ordered, by kit part number, by writing to:

Whirlpool Corporation
Attention: Customer Service Dept.
1900 Whirlpool Drive
LaPorte, IN 46350

3. Electrical requirements

Observe all governing codes and ordinances. A 120 Volt, 60 Hz, AC only, 15 or 20 amp fused electrical supply is required. (Time-delay fuse is

recommended.) It is recommended that a separate circuit serving only this appliance be provided.

4. GROUNDING INSTRUCTIONS

⚠ WARNING

Electrical Shock Hazard

Improper use of the grounding plug can result in a risk of electrical shock. DO NOT, UNDER ANY CIRCUMSTANCES, REMOVE THE POWER SUPPLY CORD GROUNDING PRONG.

5. For your personal safety, this appliance must be grounded. In the event of an electrical short circuit, grounding reduces the risk of electrical shock by providing an escape wire for the electric current. This appliance is equipped with a polarized 3-prong grounding plug. It must be plugged into a correctly polarized mating 3-prong grounding type wall receptacle, properly installed and grounded in accordance with the National Electrical Code and local codes and ordinances. If a mating wall receptacle is not available or if you are not sure if the wall receptacle is properly grounded and polarized, have it checked by a qualified electrician.

3-prong grounding
type wall receptacle

3-prong grounding
plug

Power supply cord

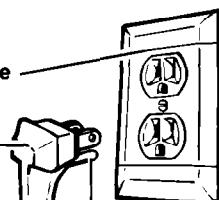

Grounding prong

It is the personal responsibility and obligation of the customer to have a properly grounded and correctly polarized 3-prong wall receptacle installed by a qualified electrician.

Consult a qualified electrician if the grounding instructions are not completely understood, or if doubt exists as to whether the appliance is properly grounded.

It is not recommended to use an extension cord with your microwave oven, but if you find it necessary to do so temporarily (until a properly grounded and polarized 3-prong receptacle is installed), use only a heavy duty UL listed 3-wire grounding type extension cord containing three 16-gauge (minimum) copper wires. It must not be longer than 10 feet (cords longer than 10 feet may affect the cooking performance of your microwave oven). The plug on the extension cord must fit into a 3-prong grounding type wall receptacle (as shown on this page) and the receptacle end of the extension cord must accept the 3-prong grounding plug of the microwave oven.

6.  To test the oven, plug it into the proper electrical outlet. Put about one cup (250mL) of cold water in a glass container in the oven.

Close the door. Make sure it latches. Follow the directions on page 12 to set the oven to cook for 2 minutes. When the time is up, the water should be heated.

7. **This microwave oven is designed for use in the household only and must not be used for commercial purposes.**

Do not remove the door, control panel or cabinet at any time. The unit is equipped with high voltage and should be serviced by an authorized Whirlpool® service technician.

- SAVE THESE INSTRUCTIONS -

Caring For Your Microwave Oven

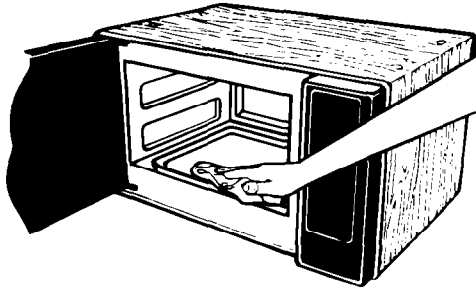

Wipe often with warm, sudsy water and a sponge or paper towel. The glass tray may be removed for cleaning. **Do not** operate the microwave oven when glass tray is removed for cleaning. See page 31 for further information about the tray.

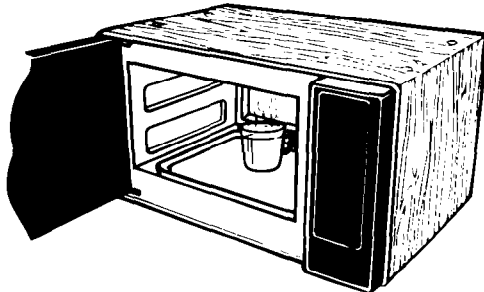

For stubborn soil, boil a cup of water in the oven for 2 or 3 minutes. Steam will soften the soil.

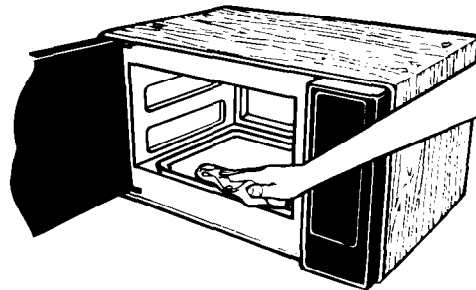

Be sure to keep the areas clean where the door and oven frame touch when closed. Use only mild, nonabrasive soaps or detergents applied with a sponge or paper towel when cleaning surfaces. Rinse well.

CAUTION

Product Damage Hazard

Abrasive cleansers, steel-wool pads, gritty wash cloths, etc., could damage the control panel, and the interior and exterior oven surfaces. Use a sponge with a mild detergent or a paper towel with spray glass cleaner. Apply spray glass cleaner to paper towel; do not spray directly on oven.

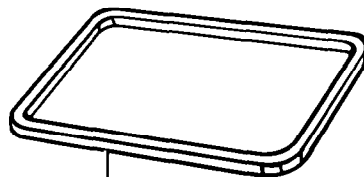

Glass tray

To clean glass tray, wash in mild, sudsy water; for heavily soiled areas use a mild cleanser and scouring sponge. The glass tray is dishwasher-safe.

How Your Microwave Oven Works

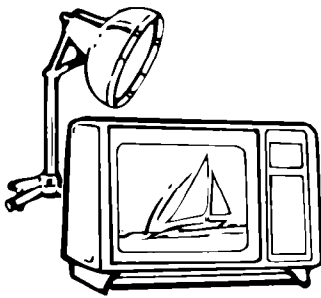

Microwave ovens are safe. Microwave energy is not hot. It causes food to make its own heat, and it's this heat that cooks the food.

Microwaves are like TV waves or light waves. You cannot see them, but you can see what they do.

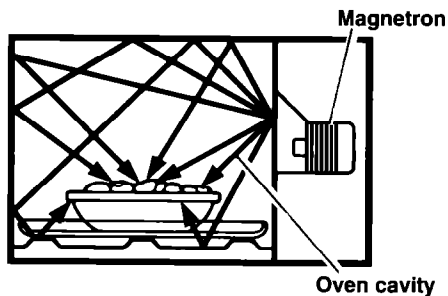

A magnetron in the microwave oven produces microwaves. The microwaves move into the oven where they are scattered or stirred by a mode mixer (like a fan). Microwaves bounce off metal oven walls and are absorbed by food.

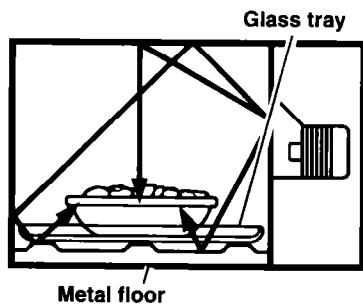

The glass tray of your microwave oven lets microwaves pass through. Then they bounce off a metal floor, back through the glass tray and are absorbed by the food.

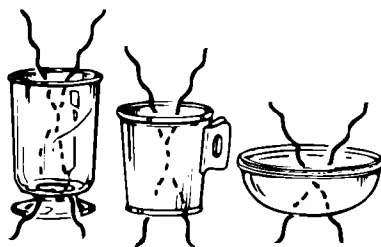

Microwaves pass through most glass, paper and plastics without heating them so food absorbs the energy. Microwaves bounce off metal pans so food does not absorb the energy.



Microwaves may not reach the center of a roast. The heat spreads to the center from the outer, cooked areas just as in regular oven cooking. This is one of the reasons for letting some foods (for example, roasts or baked potatoes) stand for a while after cooking, or for stirring some foods during the cooking time.

The microwaves disturb water molecules in the food. As the molecules bounce around bumping into each other, heat is made, like rubbing your hands together. This is the heat that does the cooking.

Operating Safety Precautions

⚠ WARNING

To reduce the risk of burns, fire, electrical shock, injury to persons, or damage when using the microwave oven, follow the precautions on pages 29-32.



Never cook or reheat a whole egg. Steam buildup in whole eggs may cause them to burst and burn you, and possibly damage the oven. Slice hard-boiled eggs before heating. In rare instances, poached eggs have been known to explode. Cover poached eggs and allow a standing time of one minute before cutting into them.



Stir before heating

For best results stir any liquid several times before heating or reheating. Liquids heated in certain containers (especially cylindrical-shaped containers) may become overheated. The liquid may splash out with a loud noise during or after heating or when adding ingredients (coffee, etc.) resulting in harm to the oven and possible personal injury.

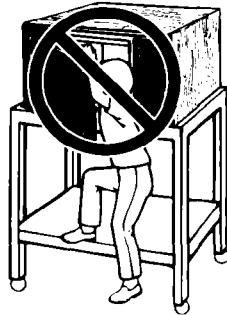

Never lean on the door or allow a child to swing on it when the door is open. Injury could result.

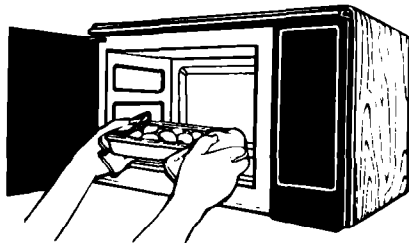

Use hot pads. Microwave energy does not heat containers, but the hot food does.

**Operating Safety Precautions
Continued**

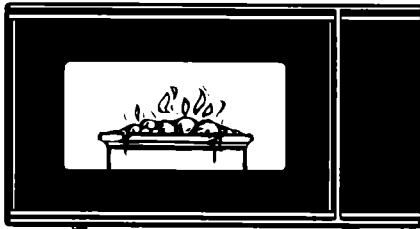
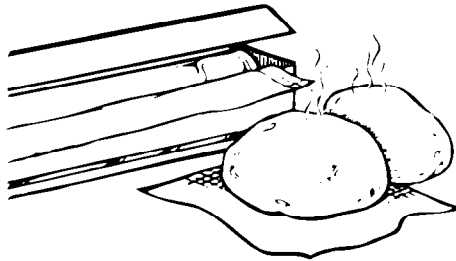
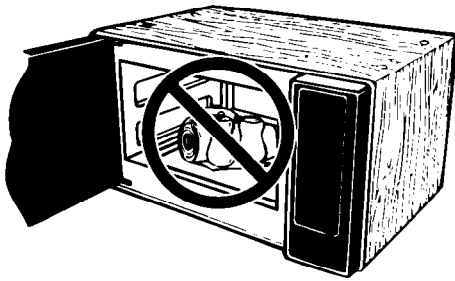

Do not do canning of foods in the oven. Closed glass jars may explode resulting in damage to the oven or possible personal injury.

Do not use the oven to sterilize objects (baby bottles, etc.). It is difficult to maintain the high temperature required for safe sterilization.

Do not deep fry in the oven. Microwavable utensils are not suitable and it is difficult to maintain appropriate deep frying temperatures.

Do not use the oven for storage. Do not leave anything in the oven when not in use. Fire may result if someone accidentally starts the oven.

Do not let food or container touch the top or sides of the oven.

Do not heat, store or use flammable materials in or near the oven. Fumes can create a fire hazard or explosion.

Do not overcook potatoes. Fire could result. At the end of the recommended cooking time potatoes should be slightly firm because they will continue cooking during standing time. After microwaving, wrap potatoes in foil and set aside for 5 minutes. They will finish cooking while standing.

If a fire should start in the oven cavity:

- **Do not open the oven door.**
- **Touch OFF/CANCEL to turn oven off.**
- **Unplug the oven or turn off the power at the main power supply.**

Do not pop popcorn, except in a microwave-approved popcorn popper or commercial package designed especially for microwave ovens.

Never try to pop popcorn in a paper bag not designed for microwave oven use. Overcooking may result in smoke and fire.

Do not repop unpopped kernels.

Do not reuse popcorn bags.

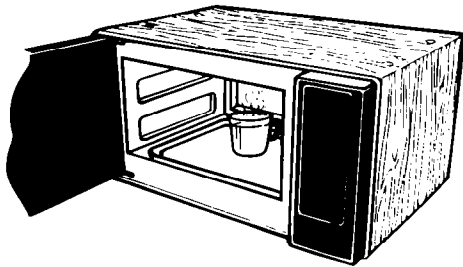

Starting a microwave oven when it is empty is not recommended. Product life may be shortened.

If you practice programming the oven, put a container of water in the oven.

It is normal for the oven door to look wavy after the oven has been running for a while.

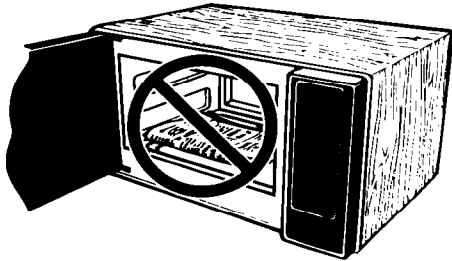

Do not use newspaper or other printed paper in the oven. Fire could result.

Do not dry flowers, fruit, herbs, wood, paper, gourds or clothes in the oven. Fire could result.



Do not try to melt paraffin wax in the oven.

Paraffin wax will not melt in a microwave oven because it allows microwaves to pass through it.

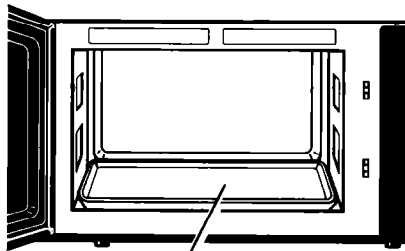

Glass tray

Glass tray

Do not operate the microwave oven unless the glass tray is securely in place.

Carefully place cookware on glass tray to avoid possible breakage.

Handle glass tray with care when removing from oven to avoid possible breakage. If glass tray cracks or breaks, contact your Whirlpool dealer for a replacement.

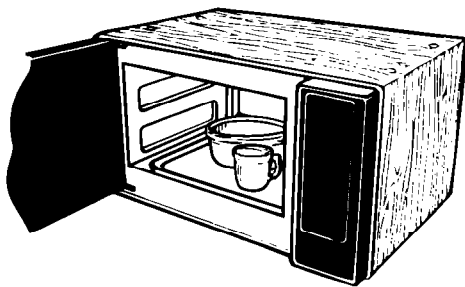
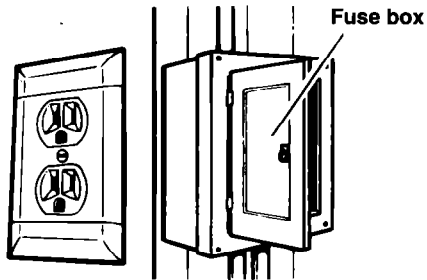

General information

If your electric power line or outlet voltage is less than 110 volts, cooking times may be longer. Have a qualified electrician check your electrical system.

To test a dish for safe use, put it into the oven with a cup of water **beside it**. Cook at 100% Cook Power for one minute. **If the dish gets hot and water stays cool, do not use it.** Some dishes (melamine, some ceramic dinnerware, etc.) absorb microwave energy, becoming too hot to handle and slowing cooking times.

⚠CAUTION

Product Damage Hazard

Remove wire twist-ties from paper or plastic bags before placing bag in oven. Cooking in metal containers not designed for microwave use can damage the oven, as can containers with hidden metal (twist-ties, foil lining, staples, metallic glaze or trim).

Radio interference

Operation of the microwave oven may cause interference to your radio, TV or similar equipment. When there is interference, it may be reduced or eliminated by taking the following measures:

- **Clean** door and sealing surfaces of the oven.
- **Adjust** the receiving antenna of radio or television.
- **Move** the receiver away from the microwave oven.
- **Plug** the microwave oven into a different outlet so that the microwave oven and receiver are on different branch circuits.

If You Need Service Or Assistance ...

We suggest you follow these steps:

1. Before calling for assistance ...

Performance problems often result from little things you can find and fix without tools of any kind.

If nothing operates:

- Is the power supply cord plugged into a live circuit with the proper voltage? (See pages 26 and 32.)
- Have you checked your home's main fuses or circuit breaker box?
- Have you checked the electric company for a power failure?

If the microwave oven will not run:

- Is the oven being used as a timer?
- Is the door firmly closed and latched?
- Did you touch START/ENTER?
- Did you follow the directions exactly?
- Did you touch OFF/CANCEL to cancel previous programming?

If the microwave cooking times seem too long:

- Is the electric supply to your home or wall outlets low or lower than normal? Your electric company can tell you if the line voltage is low. Your electrician or service technician can tell you if the outlet voltage is low.
- Is the Cook Power at the recommended setting?
- Are you allowing for more time when cooking more food at one time?

If the Display shows a time counting down but the oven is not cooking:

- Is the oven door closed completely?
- Have you set the controls as a minute timer?

If you do not hear the Programming Tone:

- Is the command correct?

If the fan seems to be running slower than usual:

- Has the oven been stored in a cold area? The fan will run slower until the oven warms up to normal room temperature.

If the food does not heat and the fan is running and the light is on:

- Is the Child Lock feature on? This feature inactivates the magnetron, but does not inactivate the fan and light. See "Using child lock" on page 20 for instructions on canceling Child Lock.

If there has been a power interruption, the Display will show "12:00⁰⁰". Reset the clock. (See page 11.)

**If You Need Service Or Assistance
Continued**

2. If you need assistance* ...

**Call Whirlpool Consumer Assistance Center
telephone number. Dial toll-free from any-
where in the U.S.A.:**

1-800-253-1301

and talk with one of our trained consultants. The consultant can instruct you in how to obtain satisfactory operation from your appliance or, if service is necessary, recommend a qualified service company in your area.

If you prefer, write to:

Mr. William Clark
Consumer Assistance Representative
Whirlpool Corporation
2000 N State Route 63
Benton Harbor, MI 49022-2692

Please include a daytime phone number in your correspondence.

3. If you need service* ...



Whirlpool has a nationwide network of authorized Whirlpool® service companies. Whirlpool service technicians are trained to

fulfill the product warranty and provide after-warranty service, anywhere in the United States. To locate the authorized Whirlpool service company in your area, call our Consumer Assistance Center telephone number (see Step 2) or look in your telephone directory Yellow Pages under:

**• APPLIANCE-HOUSEHOLD-
MAJOR, SERVICE & REPAIR**

- See: Whirlpool Appliances or
Authorized Whirlpool Service
(Example: XYZ Service Co.)

**• WASHING MACHINES &
DRYERS, SERVICE & REPAIR**

- See: Whirlpool Appliances or
Authorized Whirlpool Service
(Example: XYZ Service Co.)

**4. If you are not satisfied with how the problem
was solved* ...**

- Contact the Major Appliance Consumer Action Panel (MACAP). MACAP is a group of independent consumer experts that voices consumer views at the highest levels of the major appliance industry.
- Contact MACAP only when the dealer, authorized servicer and Whirlpool have failed to resolve your problem.
 - Major Appliance Consumer Action Panel
20 North Wacker Drive
Chicago, IL 60606
- MACAP will in turn inform us of your action.

*When requesting assistance, please provide: model number, serial number, date of purchase, and a complete description of the problem. This information is needed in order to better respond to your request.

Cooking Guide

Introduction

1. How your microwave oven works

Microwaves are a form of energy similar to radio and television waves. Your microwave oven is constructed in such a way as to take advantage of microwave energy. Electricity is converted into microwave energy by the magnetron tube, and microwaves are then sent into the oven cavity through openings at the top of the oven. Microwaves reflect off the metal walls of the oven. Since microwaves do not penetrate metal, cooking utensils made of metal are not used for cooking in the microwave. They can neither reflect nor absorb the microwaves. The microwaves can, however, be transmitted through glass, paper, wicker and microwavable cooking dishes. Microwaves do not heat the cookware, though vessels will eventually feel hot from the heat generated by the food. Microwaves are attracted to the moisture in foods and cause the water molecules to vibrate 2,450 million times per second. This is called absorption. As the water molecules vibrate they rub against each other, producing friction. This friction, in turn, causes the food to get hot. If you have trouble imagining how this is possible, just think how hot your hands would get if you rubbed your palms together 2,450 million times per second!

A very safe appliance: Your microwave oven is one of the safest of all home appliances. When the door is opened, the oven automatically stops producing microwaves. By the time microwave energy has been converted into heat in the process of making food hot, the microwaves have completely dissipated.

2. Getting the best results from your microwave oven

Keeping an eye on things: The recipes in this book have been formulated with great care, but your success in preparing them depends on how much attention you pay to the food as it cooks. Your microwave oven is equipped with a light that turns on automatically when the oven is in operation. You can see inside the oven and check the progress of your food. Directions given in recipes to stir, rotate, etc., should be thought of as the minimum steps recommended for even cooking and speed in the microwave.

Factors affecting cooking time: The cooking times given in the recipes in this book are approximate. Many factors affect cooking times. The temperature of ingredients used in a recipe makes a big difference in the cooking time. For example a cake made with cold butter, milk, and eggs will take considerably longer to bake than one made with ingredients that are at room temperature.

Range of cooking times: Most of the recipes in this book give a range of cooking times. In general, you will find that the food remains undercooked at the lower end of the time range. You may sometimes want to cook your food beyond the maximum time given. Personal preferences vary, as do the cooking speeds of different ovens under different conditions. While undercooked food may always be cooked a bit more, overcooked food can be ruined.

Some of the recipes, particularly those for breads, cakes, and meats suggest that food be removed from the oven when it is still slightly undercooked. This is not a mistake. When allowed to stand, the food will continue to cook outside the oven, as the heat trapped within the outer portions of the food gradually travels inward. If the food is left in the oven until it is cooked all the way through, the outer portions will become overcooked. As you gain experience in using your microwave oven, you will become increasingly skillful in estimating both cooking and standing times for various foods.

3. How characteristics of foods affect microwave cooking

Quantity: The greater the volume of food, the longer it takes to cook it. In general, cooking time is increased by almost 50 percent when doubling a recipe. Time is reduced by approximately 40 percent when cutting a recipe in half.

Density: Light, porous food such as cakes and breads cook more quickly than heavy, dense food such as roasts, potatoes, and casseroles.

Height: Whether conventional or microwave cooking methods are used, areas of food close to the energy source may need to be turned over or shielded for even cooking.

Shape and Size: For more even cooking results, choose food pieces that are similar in size and shape. Arrange small, thin pieces toward the center of the dish and thicker pieces toward the outside of the dish.

Sugar, Fat, and Salt: Food with high sugar, fat, and salt content cooks faster than food low in these elements.

4. Special techniques in microwave cooking

Browning: Meat and poultry with high fat content that are cooked 10 to 15 minutes or longer will brown lightly. Food that is cooked for a shorter period of time may be brushed with a browning agent to achieve an appealing color. The most commonly used browning sauces are Worcestershire sauce, soy sauce and barbecue sauce.

Covering: A cover traps heat and steam causing the food to cook more quickly. You may either use a lid or plastic wrap with a corner folded back to vent the excess steam. Recipes calling for covered microwavable casseroles use the glass casserole covers to help retain the steam; however, the covers can become hot during cooking so handle carefully. Wax paper effectively prevents food from spattering in the oven and helps food retain some heat. Sandwiches and many other foods can be wrapped in paper towels to prevent them from drying out.

Spacing: Individual foods such as baked potatoes, cupcakes, and hors d'oeuvres will cook more evenly if placed in the oven at least an inch apart, preferably in a circular pattern.

Stirring: Stirring is an important microwaving technique. Microwaved foods are stirred in order to blend flavors and redistribute heat. Always stir from the outside toward the inside, since the outside of the food heats first.

Turning Over: Larger sized food such as roasts and whole poultry should be turned over so that the top and bottom will cook evenly. It is also a good idea to turn over chicken pieces and chops.

Arrangement: Since dense foods cook more slowly in the microwave, it makes sense to place thicker portions of meat, poultry, fish and vegetables to the outer edge of the baking dish. This way, thicker portions will receive the most microwave energy and the food will cook evenly. Also, arrange food in a single layer, rather than stacking, to permit more even cooking.

Shielding: Strips of aluminum foil, which block microwaves, are sometimes placed over the corners or edges of square and rectangular shaped pans to prevent those portions from overcooking. Irregular food shapes such as poultry legs and wings tips can be shielded with foil to keep them from overcooking. Keep foil at least one inch from the oven walls.

Piercing: To prevent bursting, food enclosed in a shell, skin or membrane must be pierced prior to cooking. Such foods include both the yolks and whites of eggs, hot dogs, clams, oysters, and many whole vegetables, such as potatoes and squash.

Testing for Doneness: Because foods cook so quickly in a microwave oven, it is necessary to test for doneness frequently. Check recipes for specific information.

Standing Time: Food is often allowed to stand for 2 to 10 minutes after being removed from the microwave oven. Usually the food is covered during standing time to retain heat. Most foods are removed from the oven while still slightly undercooked, and finish cooking during standing time. The internal temperature of food will rise about 10° during standing time.

5. Microwave-safe utensils

Never use metal or metal-trimmed utensils in your microwave oven. Microwaves cannot penetrate metal. They will bounce off any metal object in the oven and cause "arcing," which resembles lightning. Most heat-resistant, nonmetallic cooking utensils are safe for use in your microwave oven. However, some may contain materials that render them unsuitable for microwave cooking. If you have any doubts about a particular utensil, there's a simple way to find out if it can be used in your microwave oven:

Testing Utensils for Microwave Use: Place the utensil in question next to a glass measure filled with water in the microwave oven. Cook 1 minute at HIGH power. If the water is warm and the utensil remains cool, the utensil is microwavable. However, if the utensil becomes warm, microwaves are being absorbed by the utensil and it should not be used in the microwave oven.

You probably have many items on hand in your kitchen right now that can be used as cooking equipment in your microwave oven. Read through the following checklist:

1. Dinner Plates: Many kinds of tableware are microwavable. This would include most brands of oven-tempered glass cookware.

2. Glassware: Some glassware that is heat-resistant is microwavable. This would include all brands of oven-tempered glass cookware. Do not, however, use delicate tumblers, wine glasses, etc. in the oven, as they may possibly shatter.

3. Paper: Paper plates and containers without wax coating are convenient and safe to use in your microwave oven for short cooking times. Paper towels are also very useful for absorbing moisture and grease. In general, use white paper, as some dyes may separate.

4. Plastic Storage Containers: These can be used to hold foods that are to be quickly reheated. However, they should not be used to heat foods that will need considerable time in the oven, as hot foods will eventually warp or melt the containers.

5. Cooking Bags: Cooking bags are microwavable. Make sure to make a slit in the bag so that steam can escape. Substitute string or microwavable closure for metal twist ties.

6. Plastic Microwave Cookware: A variety of cookware is available. Certain specialty items such as plastic ring molds, muffin pans, etc. are convenient. Check the manufacturer's instructions.

7. Pottery, Stoneware, and Ceramic: Containers made of these materials are usually fine for use in your microwave oven. They should be checked by using the dish test.

8. Wicker, Straw, Wood: All of these materials are safe for brief use in your microwave oven. Remove any metal fittings.

9. Metal Utensils: Metal utensils and utensils with metal straps, clips, or screws should not be placed in your microwave oven while the oven is in operation. Use wooden skewers, which are available at most cookware shops.

10. Browning Skillets: Browning skillets or grills are useful to provide extra surface browning of meats such as steaks and hamburgers. They heat to a very high temperature and should be handled with great care. Follow the manufacturer's guidelines for directions and proper use.

6. Some microwaving tips

Boiling Water: Place 1 cup of water in a 2-cup glass measure and cook uncovered 2½ to 3½ minutes at HIGH power, or until boiling.

Instant Coffee: Place 6 ounces of water in a microwavable cup or mug. Cook uncovered 2 to 2½ minutes at HIGH power, or until hot. Stir in coffee crystals.

Hot Cocoa: Place 1 or 2 teaspoons each of cocoa powder and sugar in an 8-ounce mug. Gradually add 6 ounces of milk stirring to blend. Cook uncovered 2 to 3 minutes at Cook Power 8, or until hot, stirring once.

NOTE: For safe heating of liquids in a microwave oven, see "Operating Safety Precautions" on page 29.

Heating Syrup or Honey: Place in a glass pitcher and cook uncovered at HIGH power until warm. Stir once. One cup syrup or honey will take 2 to 3 minutes.

Melting Butter or Margarine: Place butter or margarine in a custard cup or glass measuring cup. Cook uncovered at HIGH power until melted.

Softening Butter, Margarine or Cream Cheese: Unwrap and place on a serving plate. Cook uncovered at Cook Power 2, checking at 20-second intervals.

Melting Chocolate Squares and Chocolate Pieces: Place in a custard cup or glass bowl and cook uncovered at HIGH power. One square of unsweetened chocolate or 1 cup of chocolate pieces will take 1 minute 15 seconds. Two squares of unsweetened chocolate or 2 cups of chocolate pieces will take 2 minutes 30 seconds. Stir until smooth.

Melting Caramels: Combine one 14-ounce package of caramels and 2 tablespoons of water in a 4-cup glass measuring cup. Cook uncovered 2 minutes 15 seconds at HIGH power, or until melted, stirring every minute.

Toasting Almonds: Place sliced or slivered almonds in a shallow baking dish and add 1 teaspoon of butter or margarine per ½ cup of nuts. Cook uncovered 3 to 4 minutes at HIGH power, or until light brown, stirring every minute.

Toasting Coconut: Place unsweetened, flaked or grated coconut in a 9-inch glass pie plate. Cook uncovered 2 minutes to 2 minutes 15 seconds at HIGH power, or until light brown. Stir every minute.

Freshening Up Stale Chips and Pretzels: Place chips or pretzels in a napkin-lined wicker basket. Cook uncovered about 30 seconds per cup at HIGH power, or until snacks feel warm. Let stand a few minutes to cool before serving.

Warming Bread and Rolls: Wrap in a napkin or place in a napkin-lined wicker basket. Cook uncovered 30 seconds to 1 minute at Cook Power 8, or until bread or rolls feel warm.

Cooking Bacon: Place bacon slices on a double thickness of paper towel on a paper plate and cover with a paper towel. Cook uncovered 1 to 1½ minutes per slice at HIGH power, or until crisp. If you wish to save the drippings, cook bacon on a rack placed inside a microwavable baking dish.

**Cooking Guide
Continued**

Microwave cook power chart

Your microwave oven is equipped with ten Cook Powers (11 Cook Powers including 0) to give you maximum flexibility and control over cooking. When your cooking program is completed, two short tones and one long tone automatically sound. The table below will give you some idea of which foods are prepared at each of the various Cook Powers.

COOK POWER	USE
High (100%)	Boil water Brown ground beef Make candy Cook poultry pieces, fish fillets Cook vegetables Cook tender cuts of meat Melt chocolate
9 (90%)	Reheat rice, pasta and vegetables
8 (80%)	Reheat prepared foods quickly Reheat sandwiches
7 (70%–Medium High)	Cook whole fish Cook meatloaf Cook cakes, breads Cook casseroles Cook rib roasts
6 (60%)	Cook veal Cook puddings and custards
5 (50%–Medium)	Cook ham, whole poultry, lamb Cook pot roast Cook quiches
3 (30%–Medium Low)	Defrost most foods (See Auto Weight Defrosting on page 15 for meat, poultry and fish.)
2 (20%)	Take chill out of fruit Clarify butter Soften butter and cream cheese
1 (10%–Low)	Raising yeast dough Keep casseroles and main dishes warm
0 (0%)	Standing time Timer

Auto weight defrost guide

Meat

FOOD	SETTING	AT TONE	SPECIAL INSTRUCTIONS
Beef			Meat of irregular shape and large, fatty cuts of meat should have the narrow or fatty areas shielded with foil at the beginning of a defrost sequence.
Ground beef (bulk)	MEAT	Remove thawed portions with fork. Turn over. Return remainder to oven.	Do not defrost less than ¼ lb. Freeze in a doughnut shape.
Ground beef (patties)	MEAT	Separate and rearrange.	Do not defrost less than two 4-oz patties. Depress center when freezing. Place on microwavable roast rack.
Pot roast	MEAT	Turn over. Cover warm areas with aluminum foil.	Place on microwavable roast rack.
chuck roast	MEAT	Turn over. Cover warm areas with aluminum foil.	Place on microwavable roast rack.
Rib roast	MEAT	Turn over. Cover warm areas with aluminum foil.	Place on microwavable roast rack.
Rolled rump roast	MEAT	Turn over. Cover warm areas with aluminum foil.	Place on microwavable roast rack.
Round steak	MEAT	Turn over. Cover warm areas with aluminum foil.	Place on microwavable roast rack.
Stew beef	MEAT	Remove thawed portions with fork. Separate remainder. Return remainder to oven.	Place on microwavable baking dish.
Tenderloin steak	MEAT	Turn over. Cover warm areas with aluminum foil.	Place on microwavable roast rack.
Lamb			
Chops (1-inch thick)	MEAT	Separate and rearrange.	Place on microwavable roast rack.
Cubes for stew	MEAT	Remove thawed portions with fork. Separate remainder. Return remainder to oven.	Place on microwavable baking dish.
Rolled roast	MEAT	Turn over. Cover warm areas with aluminum foil.	Place on microwavable roast rack.
Pork			
Bacon	MEAT	Separate and rearrange.	Place on microwavable roast rack.
Chops (½-inch thick)	MEAT	Separate and rearrange.	Place on microwavable roast rack.
Country-style ribs	MEAT	Turn over. Cover warm areas with aluminum foil.	Place on microwavable roast rack.
Hot dogs	MEAT	Separate and rearrange.	Place on microwavable roast rack.
Rolled roast, boneless	MEAT	Turn over. Cover warm areas with aluminum foil.	Place on microwavable roast rack.
Sausage (bulk)	MEAT	Remove thawed portions with fork. Turn over. Return remainder to oven.	Place on microwavable baking dish.
Sausage links	MEAT	Separate and rearrange.	Place on microwavable roast rack.
Spareribs	MEAT	Turn over. Cover warm areas with aluminum foil.	Place on microwavable roast rack.
Veal			
Cutlets (1 lb, ½-inch thick)	MEAT	Separate and rearrange.	Place on microwavable roast rack.

**Cooking Guide
Continued**

Poultry

FOOD	SETTING	AT TONE	SPECIAL INSTRUCTIONS
Chicken Breasts (boneless) Cut up Whole (under 4 lbs)	POULTRY POULTRY POULTRY	Separate and turn over. Cover with wax paper. Separate pieces and rear- range. Turn over. Cover warm areas with aluminum foil. Turn over (end defrost breast- side down). Cover warm areas with aluminum foil.	No poultry over 5.9 lbs should be defrosted using Auto Weight Defrost, nor should whole turkeys be defrosted with this setting. Place on microwavable roast rack. Finish defrosting by immersing in cold water. Place on microwavable roast rack. Finish defrosting by immersing in cold water. Place chicken breast-side up on microwavable roast rack. Finish defrosting by immersing in cold water. Remove giblets when chicken is partially defrosted.
Cornish Hens Whole	POULTRY	Turn over. Cover warm areas with aluminum foil.	Place on microwavable roast rack. Finish defrosting by immersing in cold water.
Turkey Breast (under 6 lbs)	POULTRY	Turn over. Cover warm areas with aluminum foil.	Place on microwavable roast rack. Finish defrosting by immersing in cold water.

Fish and shellfish

FOOD	SETTING	AT TONE	SPECIAL INSTRUCTIONS
Fish Fillets Steaks Whole	FISH FISH FISH	Turn over. Separate fillets when partially thawed. Separate and rearrange. Turn over.	Place in microwavable baking dish. Carefully separate fillets under cold water. Place in microwavable baking dish. Run cold water over steaks to finish defrosting. Place in microwavable baking dish. Cover head and tail with foil. Do not let foil touch sides of microwave. Finish defrosting by immersing in cold water.
Shellfish Crabmeat Lobster tails Shrimp Scallops	FISH FISH FISH FISH	Break apart. Turn over. Turn over and rearrange. Break apart and rearrange. Break apart and rearrange.	Place in microwavable baking dish. Place in microwavable baking dish. Place in microwavable baking dish. Place in microwavable baking dish.

One touch cooking chart

SETTING	QUANTITY	SPECIAL NOTES
Popcorn	1 bag (3½ oz)	Use popcorn packages which are made especially for microwave cooking. Do not try to pop unpopped kernels. Heat only 1 package at a time. Do not leave the microwave oven unattended while popping popcorn.
Pizza Reheat	1 slice (3 oz)	Place one pizza slice (¼ of 10-inch cheese & sausage pizza) previously cooked, on paper towel, at either room or refrigerated temperature.
Fresh Vegetable	1 cup	Add 1 tablespoon water to 1 cup of cut-up, fresh vegetables. Cover with plastic wrap; vent one edge.
Frozen Entree	1 package (10 oz)	Remove lid from foil pan and cover with plastic wrap. Heat only 1 dinner at a time.
Baked Potato	1 medium (5 oz)	Place in center of the oven on paper towel. Pierce potato with fork several times. After cooking let stand for 2 minutes.
Dinner Plate	1 serving	Arrange food on microwavable plate. Place meaty portions and bulky vegetables to outside of plate. Cover with plastic wrap. Vent corner.

Meat

Now, with the help of your microwave oven, you can serve twice the meal in half the time. Best of all, you don't have to remember to take the meat out of the freezer in the morning for an evening meal. Defrosting techniques and fast cooking eliminate all these meal-planning roadblocks.

Cooking meat: tips & techniques

- Defrost meat completely before cooking.
- Trim off excess fat.
- Place meat fat-side down on microwavable roast rack.
- Turn over halfway through cooking to ensure even cooking.
- Arrange meat so thicker portions are toward outside of dish.
- Drain juices as they accumulate to minimize spattering and avoid undercooking bottom of meat.
- Shield thin or bony portions with strips of foil to prevent overcooking. Keep foil at least one inch from oven walls, and do not cover more than one-third of the meat at any one time.
- Cover meat with wax paper to prevent spattering.
- Let meat stand covered with foil 10 to 15 minutes after removing from microwave oven. Internal temperature of meat may rise 5°F to 15°F during standing time.
- Use oven cooking bags for less tender cuts of meat.

**Cooking Guide
Continued**

Meat cooking table

MEAT	COOK POWER	COOKING TIME	SPECIAL INSTRUCTIONS
Beef Corned beef (3 lbs)	(Cook 1), HIGH then (Cook 2), 3	15 minutes then 25-30 minutes per pound	Place corned beef in 3-quart microwavable casserole. Pour 1 cup water and desired seasonings over corned beef. Cook covered. Turn over beef during cooking. Shield thinner ends with foil. Cook until fork-tender. Let stand covered 15 minutes. Thinly slice beef diagonally across grain.
Cubes for stew (2 lbs, inch cubes)	(Cook 1), HIGH then (Cook 2), 3	10 minutes then 27-32 minutes per pound	Place cubes in 2½-quart microwavable casserole. Pour 1 cup water or broth over cubes. Cook covered. Stir cubes halfway through cooking. Cook until fork-tender. Let stand covered 10 minutes. NOTE: For faster cooking and slightly less tenderness, beef cubes for stew may be cooked at HIGH power for 10 minutes, then at Cook Power 3 for 35 minutes per pound.
Ground beef (1 lb)	HIGH	4-5 minutes	Crumble beef and place in microwavable bowl. Cover with wax paper. Stir after 2½ minutes to break meat apart. After cooking let stand covered 2 minutes. If meat is still pink, cover and cook 1 more minute.
Hamburgers, fresh or defrosted frozen (4 oz, each) 1 patty 2 patties 4 patties	HIGH	¾-1¼ minutes 1¼-2 minutes 2½-3½ minutes	Form patties with depression in center of each. Place on microwavable roast rack. Brush with browning agent, if desired. Cover with wax paper. Turn over halfway through cooking. Let stand covered 1 minute.
Pot roast (3-4 lbs)	(Cook 1), HIGH then (Cook 2), 3	15 minutes then 30-35 minutes per pound	Pierce roast deeply on both sides in several places. Place roast in large cooking bag. (Follow instructions included with cooking bag). Place in microwavable dish. Add desired seasonings and 1 cup liquid over roast. Close bag loosely with microwavable closure or string. Carefully turn over meat after 45 minutes. Continue cooking until fork-tender. Let stand covered 10 minutes.
Rib roast, rolled (3-4 lbs)	5	10-11 minutes per pound RARE (135°F) 11-13 minutes per pound MEDIUM (160°F) 12-14 minutes per pound WELL (170°F)	Place roast fat-side down on microwavable roast rack. Add desired seasonings and cover with wax paper. Turn over meat halfway through cooking and shield if necessary. Let stand covered with foil 15 minutes. (Temperature may rise about 10°F.)
Rump roast, rolled (3-4 lbs)	3	16-18 minutes per pound RARE (135°F) 18-20 minutes per pound MEDIUM (160°F)	Place roast fat-side down on microwavable roast rack. Add desired seasonings and cover with wax paper. Turn over meat halfway through cooking and shield if necessary. Remove roast from microwave when desired temperature is reached. Let stand covered with foil 15 minutes. (Temperature may rise about 10°F.)

Meat cooking table (continued)

MEAT	COOK POWER	COOKING TIME	SPECIAL INSTRUCTIONS
Sirloin tip roast (3-4 lbs)	5	9-11 minutes per pound RARE (135°F) 11-13 minutes per pound MEDIUM (160°F)	Place roast fat-side down on microwavable roast rack. Add desired seasonings and cover with wax paper. Turn over meat halfway through cooking and shield if necessary. Remove roast from microwave when desired temperature is reached. Let stand covered with foil 15 minutes. (Temperature may rise about 10°F.)
Veal cutlets (about 1 lb) 4 pieces	6	7-8 minutes per pound	Place cutlets in bottom of oiled microwavable baking dish. Add desired seasonings and cover with wax paper. Turn over and rearrange cutlets halfway through cooking. Let stand covered 2 minutes. Drain on paper towel.
Lamb Lamb roast, rolled, boneless (3-4 lbs)	5	12-13 minutes per pound RARE (140°F) 13-14 minutes per pound MEDIUM (150°F) 15-16 minutes per pound WELL (180°F)	Place roast fat-side up on microwavable roast rack. Brush lamb with marinade or desired seasonings such as rosemary, thyme or marjoram. Cover with wax paper. Turn over roast after 15 minutes and again after 30 minutes. Shield if necessary. Remove roast from microwave when desired temperature is reached. Let stand covered with foil 15 minutes. (Temperature may rise about 10°F.)
Lamb stew cubes (2 lbs)	(Cook 1), HIGH then (Cook 2), 3	10 minutes 30 minutes per pound	Place cubes in 2-quart microwavable casserole. Add desired seasonings such as rosemary, thyme and marjoram and 1 cup water. Cook covered. Stir cubes twice during cooking. Cook until fork-tender. Let stand covered 15 minutes.
Pork Bacon slices 2 slices 4 slices 6 slices	HIGH	1½-2 minutes 2½-3½ minutes 4-5 minutes	Place bacon slices on microwavable roast rack. Cover with paper towels. After cooking let stand 1 minute.
Canadian bacon 2 slices 4 slices 6 slices	HIGH	30-45 seconds 45 seconds-1 minute 1-1½ minutes	Place meat on microwavable roast rack. Cover loosely with wax paper. After cooking let stand 1 minute.
Chops (5-7 oz each) 2 chops 4 chops	3	19-20 minutes per pound 16-17 minutes per pound	Place chops in microwavable baking dish. Add desired seasonings and cover with vented plastic wrap. Turn over chops halfway through cooking. Let stand covered 5 minutes.

**Cooking Guide
Continued**

Meat cooking table (continued)

MEAT	COOK POWER	COOKING TIME	SPECIAL INSTRUCTIONS
Hot dogs 1 2 4	HIGH	20-30 seconds 30-45 seconds 45 seconds-1 minute	Pierce hot dogs and place on microwavable roast rack. Cover with wax paper. If in bun, wrap in paper towel or paper napkin to absorb moisture. After cooking, let stand 1 minute.
Ham, boneless fully cooked 2 lbs 5 lbs	5	13-14 minutes per pound	Place ham on microwavable roast rack. Cover with wax paper. Turn over ham halfway through cooking. Let stand covered 10 minutes.
Ham, center slice (1lb)	7	4½-5½ minutes	Place slices on microwavable roast rack. Cover with vented plastic wrap. Let stand covered 1 minute.
Loin roast, rolled, boneless (3½- 4½ lbs)	3	16-17 minutes per pound (170°F)	Place roast in cooking bag in microwavable dish. (Follow instructions included with bag.) Add seasonings and browning agent if desired. Close bag loosely with microwavable closure or string. Turn over roast halfway through cooking. After cooking let stand in bag 15 minutes. (Temperature may rise about 10°F.) Internal temperature of pork should reach 170°F before serving.
Sausage links, fresh (1-2 oz each) 2 links 4 links 6 links	HIGH	45-60 seconds 1¼-1½ minutes 1½-2 minutes	Pierce links and place on microwavable roast rack. Cover with wax paper or paper towel. After cooking let stand covered 1 minute.
Sausage patties, fresh (2 oz each) 2 patties 4 patties 8 patties	HIGH	1½-2 minutes 2½-3 minutes 4½-5 minutes	Place sausage patties in a circle on microwavable roast rack. Brush with browning agent if desired. Cover with wax paper. Turn patties over halfway through cooking. After cooking let stand 2 minutes.
Spareribs (2½-3½ lbs)	5 then 5	22-27 minutes per pound (165°F) 10 minutes	Place ribs, cut into serving-size pieces, bone-side down in large cooking bag. (Follow instructions included with bag.) Place bag in 3-quart microwavable casserole. Add 1 cup water to bag. Close bag loosely with microwavable closure or string. Turn over ribs, rearranging carefully, halfway through cooking. Cook until meat is fork-tender. Carefully remove ribs. If desired, brush sauce over ribs. Cook covered with wax paper. Let stand covered 10 minutes. (Temperature may rise about 10°F.) Internal temperature of pork should reach 170°F before serving.

Stuffed flank steak

- 1 cup finely chopped onion
- 1 clove garlic, minced
- ¼ cup butter or margarine
- 1 package (10 ounces) frozen chopped spinach, thawed and well drained
- ¼ teaspoon ground thyme
- ¼ teaspoon ground black pepper
- 1 beef flank steak (about 1½ pounds)
- 1 cup beef broth
- 1 can (10¾ ounces) condensed cream of mushroom soup
- ¼ cup white wine (optional)

1. Combine onion, garlic, and butter in a 2-quart microwavable casserole. Cook uncovered 5 to 6 minutes at HIGH power or until onion is tender; stir once. Add spinach, thyme, and pepper. Cook covered 3 minutes at HIGH power. Stir once.
2. Pound flank steak with mallet to flatten. Spread spinach mixture on steak and roll up jellyroll-fashion starting from the long edge. Tie with string. Place in 2-quart microwavable casserole.
3. Combine remaining ingredients and pour over steak. Cook covered 8½ minutes at HIGH power. Cook covered 45 to 50 minutes per pound at Cook Power 3 or until tender; turn steak over twice during cooking. Let stand covered 10 minutes.

Makes 4 servings

Poultry

Microwave-cooked chicken is juicy and succulent. Whole poultry becomes golden but not crisp. For the crispier, conventional crust, cook the poultry in your conventional oven at 450°F for 10 to 15 minutes. The same technique is also convenient when barbecuing. Defrost and precook in your microwave oven, then flash-cook on the grill for that barbecued flavor.

Cooking poultry: tips & techniques

- Defrost poultry completely before cooking.
- Arrange poultry so that thicker pieces face the outside of the baking dish. If cooking legs, arrange them like spokes of wheels.
- Cover the baking dish with wax paper to minimize spattering.
- Turn over both whole poultry and poultry pieces to ensure even cooking.
- Drain and discard juices as they accumulate.
- Shield thin or bony pieces with small strips of aluminum foil to prevent overcooking. Keep foil at least one inch from oven walls and other pieces of foil.
- Use a browning agent or cook with a sauce to give browned appearance.
- Cook poultry until no longer pink and juices run clear. Temperatures in thigh meat should be 180°F-185°F when done. Let stand covered with foil 10 minutes.

**Cooking Guide
Continued**

Poultry cooking table

POULTRY	COOK POWER	COOKING TIME	SPECIAL INSTRUCTIONS
Chicken Breasts, boneless 1 half breast (4-5 oz) 1 whole breast (10-12 oz) 2 whole breasts (20-24 oz)	HIGH	6-6½ minutes per pound 5½- 6½ minutes per pound 5-6 minutes per pound	Wash and dry poultry. Remove skin and place breasts, thickest portion to outside, in microwavable baking dish. Brush with butter or browning agent and seasonings if desired. Cover with wax paper. Cook until no longer pink and juices run clear. Let stand covered 3 minutes.
Cut up fryer (2½-3 lbs)	HIGH	5-6 minutes per pound	Wash and dry poultry. Place pieces in single layer in microwavable baking dish with thicker pieces to the outside. Brush with butter or browning agent and seasonings if desired. Cover with wax paper. Cook until no longer pink and juices run clear. Let stand covered 5 minutes.
Whole (3-3½ lbs)	5	13-14 minutes per pound	Wash and dry poultry. Place breast-side down on microwavable roast rack. Brush with butter or browning agent and seasoning if desired. Cover with wax paper. Cook ⅓ of estimated time. Turn breast-side up, brush on butter or browning agent. Replace wax paper. Cook ⅓ of estimated time again. Shield if necessary. Cook remaining ⅓ of estimated time or until no longer pink and juices run clear. Let stand covered with foil 10 minutes. (Temperature may rise about 10°F.) Temperature in thigh should be 180°F-185°F when done.
Turkey Breast, boneless (2-3 lbs)	5	18-20 minutes per pound	Place thawed turkey breast on microwavable roast rack. Cover with wax paper. Cook ⅓ of estimated time. Turn breast over. Replace wax paper. Cook ⅓ of estimated time again. Turn breast over. Shield if necessary. Cook remaining ⅓ of estimated time or until no longer pink and juices run clear. Remove from microwave when desired temperature is reached. Let stand covered with foil 10 minutes. (Temperature may rise about 10°F.) Temperature in breast should be 170°F before serving.
Breast, whole (4-9 lbs)	HIGH then 5	4 minutes per pound 7-8 minutes per pound	Wash and dry poultry. Place turkey breast meat-side down on microwavable roast rack. Brush with butter or browning agent and seasonings if desired. Cover with wax paper. After first cooking time is done, turn meat-side up. Remove and discard drippings. Brush on butter or browning agent and seasonings if desired. Replace wax paper. Cook until no longer pink and juices run clear. Remove breast from microwave when desired temperature is reached. Let stand covered with foil 10 minutes. (Temperature may rise about 10°F.) Temperature in breast should be 170°F before serving.

Poultry cooking table (continued)

POULTRY	COOK POWER	COOKING TIME	SPECIAL INSTRUCTIONS
Drumsticks (1½-2 lbs)	5	14-16 minutes per pound	Wash and dry poultry. Place pieces with thickest portion to outside on microwavable roast rack. Brush with butter or browning agent and seasonings if desired. Cover with wax paper. Turn over pieces, shield bone ends with small pieces of foil and replace wax paper halfway through cooking. Cook until no longer pink and juices run clear. Let stand covered 5 minutes.
Whole (up to 12 lbs)	HIGH then 5	4 minutes per pound then 6-7 minutes per pound	Wash and dry poultry. Place turkey, breast-side down, on microwavable roast rack. Brush with butter or browning agent and seasonings if desired. Cover with wax paper. Turn breast-side up. Brush with butter or browning agent before cooking at Cook Power 5, if desired. Remove and discard drippings 1 or 2 times during second cooking time. Cook until no longer pink and juices run clear. Let stand covered with foil 15 minutes. (Temperature may rise about 10°F.) Temperature should be 170°F to 180°F before serving.
Cornish Hens Whole (1-1½ lbs each)	HIGH	4½-5½ minutes per pound	Wash and dry poultry. Tie wings to body of hen and the legs to tail. Place hens breast-side down on microwavable roast rack. Cover with wax paper. Shield bone ends of drumsticks with foil. Remove and discard drippings. Brush with butter or browning agent and seasonings if desired. Cook until no longer pink and juices run clear. Remove hens from microwave when desired temperature is reached. Let stand covered with foil 5 minutes. (Temperature may rise about 10°F.) Temperature should be 180°F-185°F before serving.
Duckling (4-5 lbs)	HIGH then 5	10 minutes 7-9 minutes per pound	Wash and dry poultry. Tie legs together and the wings to body. Place breast-side down on microwavable roast rack. Brush with butter or browning agent and seasonings if desired. Cover with wax paper. Turn breast-side up halfway through second cooking time. Shield if necessary. Remove and discard fat 1 or 2 times during cooking. Let stand covered with foil 10 minutes. (Temperature may rise about 10°F.) Temperature should be 180°F-185°F before serving.

Fish & shellfish

Fish and shellfish cook well in the microwave oven. Their naturally high moisture content means fast cooking. In just a few minutes, your seafood will be tender and moist, keeping its true flavor and mild taste.

Cooking fish & shellfish: tips & techniques

- Completely defrost fish and shellfish before cooking.
- Arrange unevenly shaped pieces with thicker parts toward the outside of the dish. Arrange shellfish in a single layer for even cooking.
- Always use the shortest cooking time. Fish is done the moment it turns opaque and the thickest part begins to flake. Shellfish is done when the shell turns from pink to red and the flesh is opaque and firm.
- The type of cover used will determine whether fish is baked or poached. For poached fish cover with microwavable lid or plastic wrap, vented; for baked fish place wax paper over container.
- Cook fish that is coated or prepared with sauce uncovered or lightly covered with wax paper. This keeps the coatings from becoming soggy and the sauce from getting watery.

Fish and shellfish cooking table

FISH	COOK POWER	COOKING TIME MINUTES PER POUND	SPECIAL INSTRUCTIONS
Fish Fillets	HIGH	4 to 5 minutes	Arrange fish in single layer with thickest portion toward outside edge of 1½ to 2-quart microwavable baking dish. Brush with melted butter and season, if desired. Cook covered with plastic wrap; vented. Let stand covered 2 minutes.
Fish Steaks	HIGH	4 to 5 minutes	
Whole Fish	7	5½ to 6½ minutes	Prepare as directed above.
Scallops	HIGH	4 to 5 minutes	
Shrimp, shelled	HIGH	4 to 5 minutes	
Lobster Tail	HIGH	4 to 5 minutes	Cut hard shell down middle with knife. Grasp tail with both hands and open flat. Place flesh-side up in 8x8x2-inch square glass baking dish. Cook covered with wax paper. Let stand covered 2 minutes.

Poached fish fillets

- 4 Orange Roughy fillets (1 to 1¼ pound)
- ½ cup dry white wine
- 3 tablespoons butter, or margarine cut into ¼-inch slices
- 2 tablespoons finely chopped green onion
- ¼ teaspoon ground black pepper

1. Arrange fillets with thicker parts to the outside in a 2-quart microwavable baking dish. Pour wine over fillets. Dot with butter. Sprinkle with onion and pepper.
2. Cook covered with wax paper 3½ to 5½ minutes at HIGH power or until fish flakes easily when tested with fork. Let stand covered 5 minutes.

Makes 4 servings

Baked whitefish meuniere

- ½ cup butter or margarine, cut into pieces
- ¼ cup finely chopped parsley
- 1 tablespoon lemon juice
- 1½ to 2½ pounds whole whitefish, cleaned

1. Combine butter, parsley and lemon juice in a 1½-quart microwavable baking dish. Cook uncovered 1 to 2 minutes at HIGH power or until butter is melted; stir once.
2. Place fish in baking dish and turn to coat with butter mixture. Cover with plastic wrap; vent. Cook 10 to 11 minutes at Cook Power 7 or until fish flakes easily when tested with fork; turn fish over after 5 minutes cooking. Let stand covered 5 minutes.

Makes 3 to 4 servings

Cakes & pies

Make your very next cake or pie in your microwave oven. Not only will it cook in half the time, but it will be delicious! Microwave-cooked cakes are superior in texture, height, and lightness to those cooked in conventional ovens. Pie crust comes out extra flaky.

Microwave cakes & pies: tips & techniques

- When making pie fillings, slightly reduce the amount of liquid given in the conventional recipe.
- Pastry will not brown, but it does come out extra flaky. To add color, brush prepared shell with vanilla extract before cooking.
- All pies should be cooked in a microwavable pie plate. Prick pastry before cooking. To check, the bottom of the crust should look opaque and dry.
- Crumb crusts work well in the microwave oven.
- Because microwave-cooked cakes rise much higher than those conventionally baked, fill dish only half full.
- Cakes are done when a toothpick inserted near the center of the layer comes out clean. There may be some moist spots on top immediately after removing from the oven. These will disappear during the standing time.
- Angel food cake, chiffon cake and cream puffs need dry heat, so bake in a conventional oven for best results.

Convenience cakes and mixes cooking table

CAKES & MIXES	COOK POWER	COOKING TIME	SPECIAL INSTRUCTIONS
Brownie Mix (23.6 oz)	7	14-15 minutes	Prepare as directed on package. Spread batter into greased 7x11-inch microwavable baking dish. Shield corners with foil halfway through cooking. When done, top will appear puffy and dry and will spring back when lightly pressed with finger. Let stand on flat surface 10 minutes. Cool before cutting.
Cake, layer (17-18½ oz)	7	5-6 minutes	Prepare as directed on package. Divide batter between two wax paper-lined, 8-inch, microwavable cake dishes. Fill each dish half full. Any extra batter may be used for cupcakes. When done, wooden toothpick inserted near center will come out clean. Let stand on flat surface 5 minutes. Invert onto serving plate. Carefully remove wax paper. Repeat with second layer.
Cake, tube (17-18½ oz)	7	10-12 minutes	Prepare as directed on package. Pour batter into a 10-12 cup, microwavable fluted tube dish that has been greased and sprinkled with granulated sugar. When done, wooden toothpick inserted near center will come out clean. Let stand on flat surface 10 minutes. Invert onto serving plate. Cool.

Convenience cakes and mixes cooking table (continued)

CAKES & MIXES	COOK POWER	COOKING TIME	SPECIAL INSTRUCTIONS
<p>Cupcakes</p> <p>4 cupcakes</p> <p>6 cupcakes</p>	<p>7</p> <p>7</p>	<p>1½-2 minutes</p> <p>2-2½ minutes</p>	<p>Prepare as directed on package. Place 2 paper cupcake liners in each microwavable muffin ring cup. Fill each cup two-thirds full with batter (about 3 tablespoons). When done, tops will appear moist and wooden toothpick inserted near center will come out clean. Let stand 2 minutes. Remove cupcakes to rack. Repeat with remaining batter.</p>
<p>Date Bread Mix (17 oz)</p>	<p>7</p>	<p>10-11 minutes</p>	<p>Prepare as directed on package. Pour batter into wax paper-lined 9x5x3-inch microwavable loaf dish. Shield corners with foil halfway through cooking. When done, top will appear moist and wooden toothpick inserted near center will come out clean. Let stand on flat surface 5 minutes. Remove from dish and carefully peel off wax paper. Cool on rack.</p>
<p>Muffins (13 oz)</p>	<p>7</p>	<p>2½-3 minutes</p>	<p>Prepare as directed on package. Place 2 paper liners in each microwavable muffin ring cup. Fill each cup two-thirds full with batter (about 3 tablespoons). When done, tops will appear moist and wooden toothpick inserted near center will come out clean. Let stand 2 minutes. Remove muffins to rack. Repeat with remaining batter.</p>

Fruitcake

- 1 cup chopped dried apricots
- 1 cup raisins or dried currants
- 1 cup slivered almonds
- ¾ cup candied cherries, halved
- ¾ cup candied pineapple
- ¾ cup flour
- ¾ cup packed dark brown sugar
- ½ cup shortening
- 3 eggs
- 2 tablespoons rum or brandy
- 2 teaspoons vanilla extract
- ¼ teaspoon almond extract
- ½ teaspoon ground nutmeg or mace
- ½ teaspoon baking powder
- ½ teaspoon salt

1. Grease a 10-12 cup microwavable tube dish; set aside.
2. Combine ingredients in a mixing bowl; blend thoroughly. Pour batter into prepared pan. Cook 12 to 13 minutes at Cook Power 7 or until cake pulls away from the sides of the pan. Let stand 15 minutes on a flat surface before inverting onto a rack to cool. To store, wrap in foil or plastic wrap and refrigerate no longer than 4 weeks.

Makes 1 cake

Vegetables

Vegetable cooking table

VEGETABLES	COOKING TIME	SPECIAL INSTRUCTIONS
Artichokes Fresh (8 oz each) 2 medium 4 medium	HIGH 8-9 minutes 13-14 minutes	Place trimmed artichokes, right-side up, in 8-inch microwavable baking dish. Add 2 teaspoons lemon juice and 2 tablespoons water. Cover with plastic wrap and vent. Cook until lower leaves can be pulled off and base pierces easily with fork. Let stand covered 2 minutes.
Asparagus Fresh, spears (1 lb) Frozen, spears (10 oz pkg)	HIGH 8-9 minutes HIGH 7-8 minutes	Place spears in single layer in 2-quart microwavable baking dish, alternating tips and thick ends, with thickest stalks to outside of dish. Add 2 tablespoons water. Cover with plastic wrap and vent. Cook until tender-crisp. Let stand covered 2 minutes. Remove outer wrapping from box. Place box on 2 paper towels. After cooking, let stand 2 minutes.
Beans, green & wax Fresh, cut (1 lb)	HIGH 10-12 minutes	Place beans and 2 tablespoons water in 1½-quart microwavable, covered casserole. Stir halfway through cooking. Cook until tender-crisp. Let stand covered 2 minutes.
Beets Fresh (1 lb)	HIGH 14½-15½ minutes	Place beets and ¼ cup water in 1½-quart microwavable, covered casserole. Rearrange halfway through cooking. Cook until beets pierce easily with fork. Let stand covered 2 minutes. Peel after cooking.
Broccoli Fresh, spears (1 lb) Frozen, chopped (10 oz) Frozen, spears (10 oz)	HIGH 5-6 minutes HIGH 6-7 minutes HIGH 5½-6½ minutes	Place broccoli in single layer in 2-quart baking dish with flowerets toward center of dish. Add 2 tablespoons water. Cover with plastic wrap and vent. Cook until tender-crisp. Let stand covered 2 minutes. Remove outer wrapping from box. Place on 2 paper towels. After cooking let stand 2 minutes. Same as "Frozen, chopped" above.
Brussels Sprouts Fresh, (1 lb) 3-4 cups Frozen, (10 oz)	HIGH 5½-6½ minutes HIGH 5½-6½ minutes	Place brussels sprouts and 2 tablespoons water in 2-quart microwavable, covered casserole. Stir halfway through cooking. Cook until tender-crisp. Let stand covered 2 minutes. Remove outer wrapping from box. Place box on 2 paper towels. After cooking let stand 2 minutes.
Cabbage Fresh, chopped (1 lb) 1 medium Wedges (1 lb) 1 medium	HIGH 6½-7½ minutes HIGH 6½-7½ minutes	Place cabbage and ¼ cup water in 2-quart microwavable, covered casserole. Stir halfway through cooking. Cook until tender-crisp. Let stand covered 2 minutes. Place cabbage and ¼ cup water in 2-quart microwavable covered casserole. Cook until tender-crisp. Let stand covered 2 minutes.

Vegetable cooking table (continued)

VEGETABLES	COOKING TIME	SPECIAL INSTRUCTIONS
<p>Carrots Fresh, sliced 2 cups</p> <p>Frozen, crinkle cut (10 oz)</p> <p>Frozen, whole baby (10 oz pouch)</p>	<p>HIGH 5-6 minutes</p> <p>HIGH 5½-6½ minutes</p> <p>HIGH 6½-7½ minutes</p>	<p>Place carrots and 2 tablespoons water in 1-quart covered casserole. Stir halfway through cooking. Cook until fork-tender. Let stand covered 2 minutes.</p> <p>Remove outer wrapping from box. Place box on 2 paper towels. After cooking let stand 2 minutes.</p> <p>Remove pouch from box. Pierce pouch with fork. Place in 1½-quart microwavable casserole. After cooking let stand 2 minutes.</p>
<p>Cauliflower Fresh, whole (1 lb)</p> <p>Fresh, flowerets 2 cups</p> <p>Frozen, flowerets (10 oz)</p>	<p>HIGH 6-7 minutes</p> <p>HIGH 3-4 minutes</p> <p>HIGH 4½-5½ minutes</p>	<p>Place trimmed cauliflower and 2 tablespoons water in 1 or 1½-quart covered microwavable casserole. Cook until tender-crisp. Let stand covered 2 minutes.</p> <p>Same as "Fresh, whole" above.</p> <p>Remove outer wrapping from box. Place box on 2 paper towels. After cooking let stand 2 minutes.</p>
<p>Celery Fresh, sliced 4 cups, 1 inch pieces</p>	<p>HIGH 6-7 minutes</p>	<p>Place sliced celery and 2 tablespoons water in 1½-quart covered microwavable casserole. Stir halfway through cooking. Cook until tender-crisp. Let stand covered 2 minutes.</p>
<p>Corn Fresh, 2 ears 4 ears</p> <p>Frozen, on cob 2 ears 4 ears</p> <p>Frozen, kernels (10 oz)</p>	<p>HIGH 7½-9½ minutes 9½-11½ minutes</p> <p>HIGH 5-6 minutes 10½-11½ minutes</p> <p>HIGH 4-5 minutes</p>	<p>Place husked corn and 2 tablespoons water in 1½-quart microwavable baking dish. Cover with plastic wrap and vent. Cook until tender-crisp. Let stand covered 5 minutes.</p> <p>Place corn in 1½-quart microwavable baking dish. Cover with plastic wrap and vent. Cook until tender-crisp. Let stand covered 5 minutes.</p> <p>Remove outer wrapping from box. Place box on 2 paper towels. After cooking let stand 2 minutes.</p>
<p>Eggplant Fresh, whole (1 lb)</p> <p>Fresh, cubed (1 lb) 5 cups</p>	<p>HIGH 5½-6½ minutes</p> <p>HIGH 4½-5½ minutes</p>	<p>Pierce eggplant with fork and place on 2 paper towels. Turn over halfway through cooking. Cook until fork pierces skin easily. Let stand 2 minutes. Cut in half to remove pulp.</p> <p>Place eggplant and 2 tablespoons water in 2-quart microwavable, covered casserole. Stir halfway through cooking. Let stand covered 2 minutes.</p>
<p>Leeks Fresh, sliced (8 oz) 3 cups</p>	<p>HIGH 4½-5½ minutes</p>	<p>Place sliced leeks and 2 tablespoons water in 1-quart microwavable, covered casserole. Stir halfway through cooking. Let stand covered 2 minutes.</p>
<p>Mixed Vegetables Frozen (10 lb)</p>	<p>HIGH 6-7 minutes</p>	<p>Remove outer wrapping from box. Place box on 2 paper towels. After cooking let stand 2 minutes.</p>

**Cooking Guide
Continued**

Vegetable cooking table (continued)

VEGETABLES	COOKING TIME	SPECIAL INSTRUCTIONS
Mushrooms Fresh, sliced (½ lb) (1 lb)	HIGH 2½-3½ minutes 4½-5½ minutes	Place sliced mushrooms in 1 to 1½-quart microwavable, covered casserole. Stir halfway through cooking. As soon as mushrooms begin to darken, remove and let stand covered 2 minutes.
Okra Frozen, whole (10 oz) Frozen, sliced (16 oz)	HIGH 7-8 minutes HIGH 8½-9½ minutes	Remove outer wrapping from box. Place box on 2 paper towels. After cooking let stand 2 minutes. Place okra and 2 tablespoons water in 2-quart microwavable, covered casserole. Stir halfway through cooking. Let stand covered 2 minutes.
Onions Fresh, whole pearl (10 oz pkg) Fresh, chopped (8 oz) 2 medium	HIGH 4½-5½ minutes HIGH 4-5 minutes	Place peeled onions and 2 tablespoons water in 1-quart microwavable, covered casserole. Stir halfway through cooking. Cook until onions are translucent. Let stand 2 minutes. Same as "Fresh, whole" above.
Parsnips Fresh sliced (1 lb)	HIGH 5½-6½ minutes	Place parsnips and 2 tablespoons water in 1½-quart microwavable, covered casserole. Stir halfway through cooking. Cook until fork-tender. Let stand covered 2 minutes.
Pea Pods Frozen (6 oz)	HIGH 2½-3½ minutes	Remove pouch from box. Pierce pouch with fork. Place in 1-quart microwavable casserole. After cooking let stand 2 minutes.
Peas and Carrots Frozen (10 oz)	HIGH 5-6 minutes	Remove outer wrapping from box. Place box on 2 paper towels. After cooking let stand 2 minutes.
Peas, black-eyed Frozen (16 oz)	HIGH 9-10 minutes	Place peas and 2 tablespoons water in 1½-quart microwavable, covered casserole. Stir halfway through cooking. Let stand covered 2 minutes.
Peas, green Fresh (1 lb) 4 cups Frozen (9 oz pouch) Frozen (10 oz)	HIGH 11-13 minutes HIGH 3-4 minutes HIGH 3½-4½ minutes	Place shelled peas and 2 tablespoons water in 1½-quart microwavable, covered casserole. Stir halfway through cooking. Let stand covered 2 minutes. Remove outer wrapping from box or pouch. Place box on 2 paper towels. Pierce pouch with fork and place in 1½-quart microwavable casserole. After cooking let stand 2 minutes.
Potatoes, sweet Cut up (6-8 oz each) 3 medium Whole (6-8 oz each) 1 medium potato 2 medium potatoes 4 medium potatoes	HIGH 6½-7½ minutes HIGH 2-4 minutes 4-6 minutes 6-8 minutes	Place potatoes and 2 tablespoons water in 1½-quart microwavable, covered casserole. Stir halfway through cooking. Let stand covered 2 minutes. Pierce potatoes several times with fork. Place in circle on 2 paper towels. Turn over potatoes and rearrange halfway through cooking. Remove potatoes when soft to the touch. Wrap in foil and let stand 5 minutes.

Vegetable cooking table (continued)

VEGETABLES	COOKING TIME	SPECIAL INSTRUCTIONS
<p>Potatoes, white Cut up (6-8 oz each) 4 medium</p> <p>White, whole baking (6-8 oz each) 1 potato 2 potatoes 4 potatoes</p>	<p>HIGH 9-11 minutes</p> <p>HIGH 3½-5½ minutes 5½-7½ minutes 10-12 minutes</p>	<p>Place potatoes and 2 tablespoons water in 1½-quart microwavable, covered casserole. Stir halfway through cooking. Let stand covered for 2 minutes.</p> <p>Pierce potatoes several times with fork. Place in circle on 2 paper towels. Turn over potatoes and rearrange halfway through cooking. Remove potatoes when soft to touch. Wrap in foil and let stand 5 minutes.</p>
<p>Rutabaga Fresh, whole (1 lb)</p>	<p>HIGH 9½-10½ minutes</p>	<p>Pierce rutabaga through waxy coating several times with fork. Place on 2 paper towels. Remove halfway through cooking. Cut into quarters, peel and dice. Place diced rutabaga and 2 tablespoons water in 1½-quart microwavable, covered casserole. After cooking let stand covered 2 minutes.</p>
<p>Spinach Fresh, leaf (1 lb)</p> <p>Frozen, chopped (9 oz pouch) (10 oz)</p> <p>Frozen, leaf (10 oz)</p>	<p>HIGH 5½-6½ minutes</p> <p>HIGH 4½-5½ minutes 4-5 minutes</p> <p>HIGH 6½-7½ minutes</p>	<p>Place spinach and 2 tablespoons water in 3-quart microwavable, covered casserole. After cooking let stand covered 2 minutes.</p> <p>Remove outer wrapping from box or pouch. Place box on 2 paper towels. Pierce pouch with fork and place in 1½-quart microwavable casserole. After cooking let stand 2 minutes.</p>
<p>Squash, spaghetti Fresh (2-3 lbs) 1 medium whole</p>	<p>HIGH 11-12 minutes</p>	<p>Pierce squash several times with fork. Place squash on 2 paper towels. Turn over several times during cooking. Let stand 2 minutes. Cut in half. Remove fibrous strands and seeds from center.</p>
<p>Succotash Frozen (10 oz)</p>	<p>HIGH 5-6 minutes</p>	<p>Remove outer wrapping from box. Place box on 2 paper towels. After cooking let stand 2 minutes.</p>
<p>Turnips Fresh (1 lb)</p>	<p>HIGH 9-10 minutes</p>	<p>Wash and cut off the outer skin. Cut into quarters. Cook in covered 1½-quart casserole with ½ cup water. Stir once during cooking.</p>
<p>Zucchini Fresh, sliced (1 lb) 4 cups</p> <p>Fresh, whole (1 lb)</p> <p>Frozen, sliced (16 oz)</p>	<p>HIGH 7-8 minutes</p> <p>HIGH 6-7 minutes</p> <p>HIGH 7-8 minutes</p>	<p>Place zucchini and 2 tablespoons water in 1½-quart microwavable, covered casserole. Stir halfway through cooking. Let stand covered 2 minutes.</p> <p>Pierce zucchini several times with fork. Place on 2 paper towels. Turn zucchini over and rearrange halfway through cooking. Let stand 2 minutes.</p> <p>Remove outer wrapping from box. Place box on 2 paper towels. After cooking let stand 2 minutes.</p>

NOTE: Frozen vegetables, in larger or smaller quantities than listed in the chart, may be cooked approximately 3 to 4 minutes per cup of vegetables. Measure desired amount of vegetables into microwavable covered casserole and cook.

Recipes

Nachos

- 15 tortilla chips
- 3 tablespoons jalapeno bean dip
- ½ cup shredded Cheddar cheese

1. Spread each tortilla chip with bean dip; top with cheese. Place chips on a paper plate.
2. Cook uncovered 1 to 1½ minutes at Cook Power 6 or until cheese is melted.

Makes 15 appetizers

Sweet and sour tuna crackers

- 1 can (3¼ ounces) tuna, drained and flaked
- 1 package (3 ounces) cream cheese, softened
- 2 tablespoons crushed pineapple, drained
- ½ tablespoon white vinegar
- ⅙ teaspoon curry powder
- 24 crackers or melba toast rounds

1. Combine ingredients, except crackers in a mixing bowl; blend thoroughly.
2. Spread mixture on crackers. Arrange 8 crackers in a circle on a paper plate. Cook uncovered 25 to 30 seconds at HIGH power or until tuna mixture bubbles. Repeat with remaining crackers.

Makes 24 appetizers

Spaghetti sauce

- ½ cup finely chopped onion
- 1 clove garlic, pressed or finely chopped
- 2 tablespoons olive oil
- 1 can (15 ounces) tomato sauce
- 1½ teaspoons dried basil leaves
- 1½ teaspoons dried oregano leaves
- ¼ teaspoon ground black pepper

1. Combine onion, garlic, and oil in a 1-quart microwavable casserole. Cook uncovered 1 to 1½ minutes at HIGH power or until onion is tender.
2. Add remaining ingredients. Cook covered 3 minutes at HIGH power and then 8½ minutes at Cook Power 5; stir twice.

Makes about 1¾ cups

Chocolate sauce

- ¼ cup sugar
- 1 tablespoon cocoa
- 1 teaspoon flour
- dash of salt
- 2 tablespoons milk
- 2 teaspoons butter or margarine
- 2 teaspoons light corn syrup
- ¼ teaspoon vanilla extract

1. Combine dry ingredients in a 1-quart glass measuring cup; stir in milk. Add butter and corn syrup.
2. Cook uncovered 1 to 2 minutes at HIGH power or until sauce is thickened and smooth; stir twice. Stir in vanilla extract.

Makes ½ cup

Onion soup

- 1 cup thinly sliced onions
- 2 tablespoons butter or margarine
- 1 can (10½ ounces) condensed beef broth
- 1 slice of toasted French bread
- ½ cup shredded Swiss cheese
- 2 tablespoons grated Parmesan cheese

1. Combine onions and butter in a 1-quart microwavable casserole. Cook uncovered 2 to 3 minutes at HIGH power or until onions are soft; stir twice.
2. Add beef broth. Cook uncovered 2½ to 3½ minutes at HIGH power or until hot; stir once after 2 minutes.
3. Ladle into large soup bowl. Cover with bread slice and sprinkle with cheeses. Cook uncovered 45 seconds to 1 minute at HIGH power or until cheese is melted.

Makes 1 serving

Cheesy meatloaf

- ½ pound lean ground beef
- 1 egg, slightly beaten
- ⅓ cup soft, fresh bread crumbs
- ¼ cup shredded Cheddar cheese
- 3 tablespoons finely chopped onion
- 2 tablespoons tomato sauce
- 1 tablespoon finely chopped green pepper
- ⅓ teaspoon dried thyme leaves
- ⅛ teaspoon salt
- ⅛ teaspoon ground black pepper

1. Combine ingredients in a mixing bowl; mix thoroughly.
2. Shape into loaf and place on a microwavable roast rack. Cook covered with wax paper 3½ to 4½ minutes at HIGH power or until center is no longer pink. Let stand covered 5 minutes.

Makes 2 servings

Barbecued chicken

- 1½ to 2 pounds chicken pieces, skinned
- ½ cup barbecue sauce

1. Arrange chicken with thicker pieces to the outside in an 8x8x2-inch square glass baking dish. Cook covered with wax paper 2 minutes at HIGH power. Drain and turn chicken over.
2. Brush half of barbecue sauce onto chicken. Cook covered 2 minutes at HIGH power. Turn chicken over and brush with remaining sauce; cook covered 6½ to 7½ minutes at HIGH power or until juices run clear. Let stand covered 3 minutes.

Makes 2 servings

Sherried chicken

- 2½ to 3 pounds chicken, cut into serving pieces, skinned
- ¼ teaspoon ground black pepper
- 1 large onion, thinly sliced
- ⅓ cup dry sherry
- 1 tablespoon soy sauce
- 1 tablespoon lemon juice
- 1 tablespoon flour

1. Arrange chicken with thicker pieces to the outside in an 8x8x2-inch square glass baking dish. Sprinkle with pepper and top with onion. Combine remaining ingredients in a bowl. Pour mixture evenly over chicken. Cover with plastic wrap; vent.
2. Cook 15 to 17 minutes at HIGH power or until chicken is no longer pink and juices run clear; turn over halfway through cooking. Let stand covered 5 minutes. Stir pan juices until smooth and spoon over chicken.

Makes 4 servings

Basic scrambled eggs

EGGS	TABLESPOONS OF MILK	TEASPOONS OF BUTTER	COOKING TIME COOK POWER 7	SPECIAL INSTRUCTIONS
1	1	1	50 to 60 seconds	Use 10-ounce microwavable bowl or custard cup for 1 to 2 eggs; use 1-quart microwavable casserole for 4 to 6 eggs. Place butter in dish. Cook uncovered 20 to 40 seconds at HIGH power or until butter melts. Beat eggs and milk together with fork until well-blended; stir into melted butter. Cook uncovered as directed in chart at Cook Power 7. Break up and stir eggs with fork halfway through cooking. Cover with wax paper and let stand 1 to 3 minutes. Stir and season to taste.
2	2	2	2 to 2½ minutes	
4	4	4	3½ to 4 minutes	
6	6	6	5 to 6 minutes	

Basic omelet

- 1 tablespoon butter or margarine
- 2 eggs
- 2 tablespoons milk
- ½ teaspoon salt
- dash of ground black pepper

1. Place butter in a 9-inch glass pie plate. Cook uncovered 15 to 20 seconds at HIGH power or until melted. Tilt plate to cover bottom with melted butter.
2. Beat eggs, milk, salt, and pepper in a small bowl. Pour mixture into pie plate. Cook uncovered 2 to 3 minutes at Cook Power 7 or until almost set; stir after 1 minute. Cover with plastic wrap and let stand 2 minutes.

Makes 1 to 2 servings

Cheeseburgers

- 1 pound lean ground beef
- 4 slices American process cheese
- 4 hamburger buns

1. Shape ground beef into four 4-inch patties. Arrange on a microwavable roast rack. Cover with wax paper and cook 3 to 3½ minutes at HIGH power or until desired doneness; turn patties over halfway through cooking; drain liquid.
2. Top patties with cheese. Cook 30 seconds at Cook Power 6. Let stand 2 minutes. Serve on hamburger buns.

Makes 4 servings

Reuben sandwiches

- 8 slices dark rye or pumpernickel bread, toasted
- ½ pound cooked corned beef, sliced
- 1 can (8 ounces) sauerkraut, rinsed and drained
- ½ cup creamy Russian or Thousand Island dressing
- 4 slices Swiss cheese

1. Layer corned beef, sauerkraut, and dressing on 4 bread slices. Top each with cheese and remaining bread slices. Wrap each sandwich in a paper towel and place on a microwavable roast rack.
2. Cook 4½ to 5½ minutes at Cook Power 5 or until sandwich is heated through.

Makes 4 servings

Banana bread

- 2 cups buttermilk baking mix
- ½ cup packed dark brown sugar
- 3 tablespoons flour
- ¼ teaspoon ground nutmeg or mace
- ¼ cup milk
- 1 egg, slightly beaten
- ⅔ cup mashed banana
- ⅔ cup chopped dates
- ⅔ cup chopped walnuts

1. Combine baking mix, brown sugar, flour, and nutmeg in a mixing bowl, stir to blend. Combine milk, egg, and banana in a mixing bowl and add to dry mixture; stir only until dry ingredients are moistened. Stir in dates and nuts. Pour batter into a wax paper-lined 9x5x3-inch microwavable loaf dish.
2. Cook 10 to 11 minutes at Cook Power 7; shield corners with foil halfway through cooking. When done, top will appear moist and wooden toothpick inserted near center will come out clean. Let stand on a flat surface for 5 minutes. Remove from dish and peel off wax paper. Cool on rack.

Makes 1 loaf

Bran muffins

- ⅓ cup milk
- 1 egg
- ¼ cup whole bran cereal
- ¼ cup vegetable oil
- ¼ cup raisins
- ¼ cup molasses
- ¾ cup flour
- 1 teaspoon baking powder
- ¼ teaspoon baking soda
- ¼ teaspoon ground cinnamon
- ⅛ teaspoon salt

1. Beat milk and egg together in a mixing bowl, stir in bran cereal and let stand 1 minute. Stir in oil, raisins, and molasses. Add flour, baking powder, baking soda, cinnamon, and salt; stir only until dry ingredients are moistened. Place 2 paper liners in each microwavable muffin ring cup. Fill each cup two-thirds full (about 3 tablespoons).
2. Cook uncovered 2½ to 3 minutes at Cook Power 7. Remove muffins to a rack. Let stand 2 minutes.

Makes 6 muffins

Peachy cheesecake

- 1 can (16 ounces) peach halves, drained
- 1 package (8 ounces) cream cheese, softened
- ⅓ cup sugar
- 2 eggs
- 1 tablespoon lemon juice
- ¼ teaspoon vanilla extract
- 1 graham cracker crust

1. Puree peaches in blender or food processor. Add remaining ingredients, except pie crust; blend until smooth.
2. Pour mixture into crust. Cook uncovered 19½ to 20½ minutes at Cook Power 7 or until center is almost set. Cool. Chill 3 hours or overnight.

Makes 6 to 8 servings

Cherry cordial pie

- 3 cups miniature marshmallows
- ½ cup milk
- ½ cup maraschino cherries, drained and chopped
- ¼ cup cherry liqueur
- 1 cup whipping cream, whipped
- 1 9-inch baked chocolate cookie-crumb crust
- whipped cream
- maraschino cherry halves

1. Combine marshmallows and milk in a 2-quart microwavable casserole. Cook uncovered 1 to 1½ minutes at HIGH power or until marshmallows melt and puff, stir until smooth. Add chopped cherries and liqueur; blend thoroughly. Cool to room temperature about 30 minutes.
2. Fold whipped cream into marshmallow mixture and spoon filling into prepared crumb crust. Refrigerate 4 hours. Garnish with whipped cream and maraschino cherry halves.

Makes 1 pie

Cooking Guide Continued

Egg custard

- ¾ cup milk
- 2 eggs
- 2 tablespoons sugar
- 2 tablespoons grated lemon peel
- ½ teaspoon vanilla extract
- pinch of salt
- ground nutmeg

1. Pour milk into a 2-cup glass measuring cup. Cook 3½ to 4½ minutes at Cook Power 6 or until almost boiling. Beat eggs slightly in a mixing bowl; add remaining ingredients except nutmeg. Stir milk into egg mixture.
2. Pour custard mixture into two buttered 6-ounce custard cups. Place cups in oven. Cook uncovered 7 to 8 minutes at Cook Power 4 or until set. Remove cups and sprinkle with nutmeg. Set on rack to cool.

Makes 2 servings

Pineapple bread pudding

- ¼ cup butter or margarine
- 1 package (3½ ounces) instant vanilla pudding
- 1 teaspoon cinnamon
- 3 eggs, slightly beaten
- 3 cups milk
- 1 can (8¼ ounces) crushed pineapple, undrained
- ½ cup flaked coconut
- 1 teaspoon rum extract (optional)
- 8 slices white bread, French bread, or raisin-nut bread, cut into ½-inch cubes
- 1 tablespoon cinnamon-sugar

1. Melt butter in a 2-quart glass measuring cup 45 seconds at HIGH power. Add pudding mix, cinnamon, eggs, milk, undrained pineapple, coconut and rum extract; blend thoroughly.
2. Fold in bread cubes. Pour mixture into a 2-quart microwavable baking dish. Sprinkle with cinnamon-sugar. Cook uncovered 30 to 32 minutes at Cook Power 7 or until knife inserted near center comes out clean. Let stand on a flat surface for 10 minutes. Serve warm.

Makes 12 servings

Butterscotch krispie treats

- ½ cup butterscotch pieces
- 2 tablespoons butter or margarine
- 2½ cups miniature marshmallows
- 2½ cups crisp rice cereal

1. Combine butterscotch pieces and butter in a 2-quart microwavable glass casserole. Cook uncovered 2 to 3 minutes at Cook Power 7 or until melted. Stir in marshmallows. Cook uncovered 3 to 4½ minutes at Cook Power 6 or until marshmallows are softened; stir twice. Blend until smooth.
2. Stir rice cereal into marshmallow mixture. Press into buttered 8x8x2-inch microwavable baking dish. Let stand until cool and set. Cut into squares.

Makes about 25 squares

Irish coffee

- ¾ cup water
- 1 rounded teaspoon instant coffee granules
- 2 teaspoons sugar
- 2 tablespoons Irish whiskey
- whipped cream

1. Combine water, instant coffee, and sugar in an 8-ounce microwavable coffee cup. Cook uncovered 1 to 1½ minutes at HIGH power or until hot.
2. Stir in whiskey and garnish with whipped cream.

Makes about 1 cup

Appendix

Reheating

To heat or reheat successfully in the microwave, it is important to follow several guidelines. Measure the amount of food in order to determine the time needed to reheat. Arrange the food in a circular pattern for best results. Room temperature food will heat faster than refrigerated food. Canned foods should be taken out of the can and placed in a microwavable container. The food will heat more evenly if covered with a microwavable lid or plastic wrap, vented. Remove cover carefully to prevent steam burns. Use the following chart as a guide for reheating cooked food.

ITEM	COOK POWER	COOKING TIME	SPECIAL INSTRUCTIONS
Sliced Meat 3 slices (½-inch thick)	8	30 to 60 seconds	Place sliced meat on microwavable plate. Cover with plastic wrap and vent. NOTE: Gravy or sauce helps to keep meat juicy.
Chicken Pieces 1 breast 1 leg and thigh	8 8	1½ to 2 minutes 1 to 1½ minute	Place chicken pieces on microwavable plate. Cover with plastic wrap and vent.
Fish Fillet (6-8 oz)	8	1½ to 2 minutes	Place fish on microwavable plate. Cover with plastic wrap and vent.
Lasagna 1 serving (10½ oz)	8	3½ to 4½ minutes	Place lasagna on microwavable plate. Cover with plastic wrap and vent.
Casserole 1 cup 4 cups	8 8	1 to 1½ minutes 5 to 5½ minutes	Cook covered in microwavable casserole; stir once halfway through cooking.
Casserole cream or cheese 1 cup 4 cups	5 5	2 to 3 minutes 11½ to 12½ minutes	Cook covered in microwavable casserole; stir once halfway through cooking.
Sloppy Joe or Barbecued Beef 1 sandwich (½ cup meat filling without bun)	9	45 to 60 seconds	Reheat filling and bun separately. Cook filling covered in microwavable casserole; stir once. Heat bun as directed in chart on page 62.
Mashed Potatoes 1 cup 4 cups	8 8	3 to 3½ minutes 6 to 6½ minutes	Cook covered in microwavable casserole; stir once halfway through cooking.
Baked Beans 1 cup	9	2 to 2½ minutes	Cook covered in microwavable casserole; stir once halfway through cooking.
Ravioli or Pasta in sauce 1 cup 4 cups	9 9	2 to 3 minutes 7 to 8 minutes	Cook covered in microwavable casserole; stir once halfway through cooking.
Rice 1 cup 4 cups	9 9	1 to 1½ minutes 3½ to 4 minutes	Cook covered in microwavable casserole; stir once halfway through cooking.

**Cooking Guide
Continued**

Reheating (continued)

ITEM	COOK POWER	COOKING TIME	SPECIAL INSTRUCTIONS
Sandwich Roll or Bun 1 roll	8	10 to 15 seconds	Wrap in paper towel and place on roast rack.
Vegetables 1 cup 4 cups	9 9	1 to 1½ minutes 5½ to 6½ minutes	Cook covered in microwavable casserole; stir once halfway through cooking.

WHIRLPOOL®

Microwave Oven Warranty

LENGTH OF WARRANTY	WHIRLPOOL WILL PAY FOR
FULL ONE-YEAR WARRANTY From Date of Purchase	FSP® replacement parts and repair labor to correct defects in materials or workmanship. Service must be provided by an authorized Whirlpool service company.
LIMITED FOUR-YEAR WARRANTY Second Through Fifth Year From Date of Purchase	FSP replacement magnetron tube on microwave ovens if defective in materials or workmanship.
WHIRLPOOL WILL NOT PAY FOR	
<p>A. Service calls to:</p> <ol style="list-style-type: none"> 1. Correct the installation of your microwave oven. 2. Instruct you how to use your microwave oven. 3. Replace house fuses or correct house wiring. 4. Replace owner accessible light bulbs. <p>B. Repairs when your microwave oven is used in other than normal, single-family household use.</p> <p>C. Pickup and delivery. Your microwave oven is designed to be repaired in the home.</p> <p>D. Damage to your microwave oven caused by accident, misuse, fire, flood, acts of God or use of products not approved by Whirlpool.</p> <p>E. Any labor costs during limited warranty.</p> <p>F. Repairs to parts or systems caused by unauthorized modifications made to the appliance.</p>	

5/93

WHIRLPOOL CORPORATION SHALL NOT BE LIABLE FOR INCIDENTAL OR CONSEQUENTIAL DAMAGES. Some states do not allow the exclusion or limitation of incidental or consequential damages, so this limitation or exclusion may not apply to you. This warranty gives you specific legal rights, and you may also have other rights which vary from state to state.

Outside the United States, a different warranty may apply. For details, please contact your authorized Whirlpool distributor or military exchange.

If you need service, first see the "If You Need Service or Assistance" section of this book. After checking "If You Need Service or Assistance," additional help can be found by calling our Consumer Assistance Center telephone number, **1-800-253-1301**, from anywhere in the U.S.A.

® Registered Trademark of Whirlpool, U.S.A.